

2023/24

switzerland

LIVING THE LIGHT

serien
lighting

Ceiling	ANNEX	4
	CAVITY	6
	CURLING	8
	DRAFT	12
	DRUM	14
	POPPY	16
	REEF	11
	REFLEX²	19
	SLICE² PI	24
Suspension	ANNEX	58
	CAVITY	60
	CURLING	62
	DRAFT	66
	DRUM	68
	ONE EIGHTY	70
	POPPY	72
	PROPELLER	73
	REEF	74
	TWIN	75
	ZOOM	76
	ZOOM XL	76
	Wall	APP
CAVITY		105
CLUB		106
CRIB		107
CURLING		108
LID		110
POPPY		112
REEF		115
REFLEX²		116
ROD		117
SML		118
SML²		120
Table		JOB
	POPPY	156
	REFLEX²	157
	SLICE²	158
Floor	CLUB	169
	JONES	171
	POPPY	172
	REFLEX²	174
	SLICE²	176

Info	Information	205
	Awards	206
	Contacts	207
	Imprint	208

Accessories	Baldachinprofile / Canopy profiles	198
	Ersatzbezug / Replacement cover	200
	Kristallglas Anhänger / Crystal glas pendant	200
	Optiken / Optics	201
	Spiegel Adapter Set / Mirror adapter set	201
	Wandadapter / Wall adapters	202
	Wandabdeckungen / Wall cover	203



ANNEX
S. 4



CAVITY
S. 6

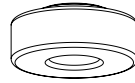

CURLING
S. 8

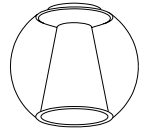

DRAFT
S. 12

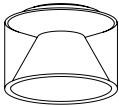

DRUM
S. 14

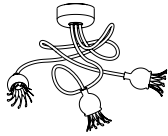

POPPY
S. 16



REEF
S. 11

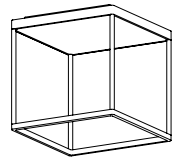

REFLEX²
S. 19



SLICE² PI
S. 24

ANNEX Ceiling

Eine geradezu archetypische Deckenleuchte mit dem Mehr an Funktionalität, auf das wir Wert legen: drei verschiedene Größen korrespondieren mit den Proportionen Ihrer Räume. Mit den unterschiedlichen Reflektoren im Innern des mundgeblasenen Kegelschirms lassen sich äußerst differenzierte Lichtwirkungen erzielen, die formal dennoch einer Familie angehören.

A quite archetypal ceiling lamp with that added functionality we value: three different sizes correspond with the proportions of your rooms. The different reflectors on the inside of the hand-blown spherical shade enable extremely varied light effects, which nonetheless formally are part of one family.

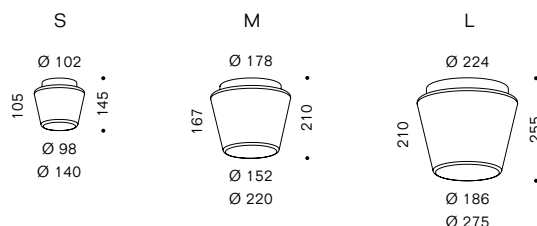

Leuchtmittel LED 9–41 W, CoB, CRI Ra>97 (R9>80), EEK/EEC E (3000 K), F (2700 K)
lamp S: G9, M: B15d, L: E27, EEK/EEC G (M, L: Lieferung ohne Leuchtmittel/delivery without bulb)

Leuchteneinheit Aluminium, hochglanzpoliert und weiß beschichtet
lighting unit aluminum, highly polished coated white

Schirm mundgeblasenes Glas klar
shade hand-blown glass clear

Ausführungen
versions



Glasschirm klar, Reflektor Acrylglas opal
Licht: nach unten gerichtet, rundum gestreut
 glass shade clear, reflector acrylic glass opal
 light: directed downwards, distributed all around





Glasschirm klar, Reflektor Aluminium poliert
Licht: nach unten gerichtet, rundum diffus
 glass shade clear, reflector: aluminium polished
 light: directed downwards, diffused all around





Glasschirm klar, Reflektor Kristallglas geschliffen mit Aluminium-Innenreflektor
Licht: nach unten gerichtet, rundum dekorativ
 glass shade clear, reflector crystal glass with aluminium reflector
 light: directed downwards, diffused all around

Sonstiges LED austauschbar; werkzeuglose Schirmmontage; 110 V-Varianten auf Anfrage
features LED exchangeable; glass shade tool-free mountable; 110 V versions on request



ANNEX Ceiling S

Abbildung figure	Beschreibung description	Leuchtmittel lamp	Regelung control	Leistung power	CCT	Lumen lumen	Art.-Nr. art.-no.	€ netto CH excl. VAT	€ brutto CH incl. VAT
	Reflektor opal reflector opal	LED	TRIAC	9 W	2700 K	1020 lm	AN3201	366,39 €	
					3000 K	1060 lm	AN3202	366,39 €	
		G9	TRIAC	max. 60 W	2700 K	980 lm	AN1013	283,95 €	
	Reflektor poliert reflector polished	LED	TRIAC	9 W	2700 K	1020 lm	AN3211	393,87 €	
					3000 K	1060 lm	AN3212	393,87 €	
		G9	TRIAC	max. 60 W	2700 K	980 lm	AN1121	306,85 €	
	Reflektor Kristall reflector crystal	LED	TRIAC	9 W	2700 K	1020 lm	AN3221	467,14 €	
					3000 K	1060 lm	AN3222	467,14 €	
		G9	TRIAC	max. 60 W	2700 K	980 lm	AN1043	384,71 €	

ANNEX Ceiling M

Abbildung figure	Beschreibung description	Leuchtmittel lamp	Regelung control	Leistung power	CCT	Lumen lumen	Art.-Nr. art.-no.	€ netto CH excl. VAT	€ brutto CH incl. VAT
	Reflektor opal reflector opal	LED	TRIAC	20 W	2700 K	1450 lm	AN3001	499,20 €	
					3000 K	1500 lm	AN3002	499,20 €	
			DALI	27 W	2700 K	2900 lm	AN3006	535,84 €	
					3000 K	3000 lm	AN3007	535,84 €	
B15d	TRIAC	max. 100 W	2800 K	1800 lm	AN1066	366,39 €			
	Reflektor poliert reflector polished	LED	TRIAC	20 W	2700 K	1450 lm	AN3011	535,84 €	
					3000 K	1500 lm	AN3012	535,84 €	
			DALI	27 W	2700 K	2900 lm	AN3015	572,48 €	
					3000 K	3000 lm	AN3016	572,48 €	
B15d	TRIAC	max. 100 W	2800 K	1800 lm	AN1078	403,03 €			
	Reflektor Kristall reflector crystal	LED	TRIAC	20 W	2700 K	1450 lm	AN3021	650,34 €	
					3000 K	1500 lm	AN3022	650,34 €	
			DALI	27 W	2700 K	2900 lm	AN3025	686,97 €	
					3000 K	3000 lm	AN3026	686,97 €	
B15d	TRIAC	max. 100 W	2800 K	1800 lm	AN1073	517,52 €			

ANNEX Ceiling L

Abbildung figure	Beschreibung description	Leuchtmittel lamp	Regelung control	Leistung power	CCT	Lumen lumen	Art.-Nr. art.-no.	€ netto CH excl. VAT	€ brutto CH incl. VAT
	Reflektor opal reflector opal	LED	TRIAC	34 W	2700 K	3850 lm	AN3047	577,06 €	
					3000 K	4010 lm	AN3048	577,06 €	
			DALI	41 W	2700 K	4500 lm	AN3051	622,86 €	
					3000 K	4680 lm	AN3052	622,86 €	
E27	TRIAC	max. 150 W	2900 K	2870 lm	AN1067	462,56 €			
	Reflektor poliert reflector polished	LED	TRIAC	34 W	2700 K	3850 lm	AN3053	622,86 €	
					3000 K	4010 lm	AN3054	622,86 €	
			DALI	41 W	2700 K	4500 lm	AN3057	668,66 €	
					3000 K	4680 lm	AN3058	668,66 €	
E27	TRIAC	max. 150 W	2900 K	2870 lm	AN1079	512,94 €			
	Reflektor Kristall reflector crystal	LED	TRIAC	34 W	2700 K	3850 lm	AN3041	796,89 €	
					3000 K	4010 lm	AN3042	796,89 €	
			DALI	41 W	2700 K	4500 lm	AN3045	842,69 €	
					3000 K	4680 lm	AN3046	842,69 €	
E27	TRIAC	max. 150 W	2900 K	2870 lm	AN1074	668,66 €			

CAVITY Ceiling & Recessed

Ein speziell konzipierter, kurvenförmiger Aluminiumkörper mit vertieft sitzendem Leuchtmittel ersetzt beim Strahler CAVITY den Reflektor und erlaubt eine freie Entfaltung des Lichts, das über die Trichterform scheinbar nach außen fließt. Es entsteht ein Downlight mit einem blendfreien und sanften Licht, das aus jedem Winkel angenehm wirkt. Unterschiedliche Beleuchtungsaufgaben können einheitlich durch Kombination von Aufbau- und Einbaustrahlern mit den Pendelleuchten sowie den Wandleuchten dieser Produktfamilie gelöst werden.



A specially designed, curved aluminum body including the recessed illuminant replaces the reflector in spotlight CAVITY and allows the light to unfold freely, seemingly flowing outwards via the funnel shaped form. The result is a glare-free and soft downlight, that is pleasant from all angles. Different lighting tasks can be solved consistently by combining the surface-mounted and recessed spotlights with the pendant luminaires and wall luminaires of this product family.

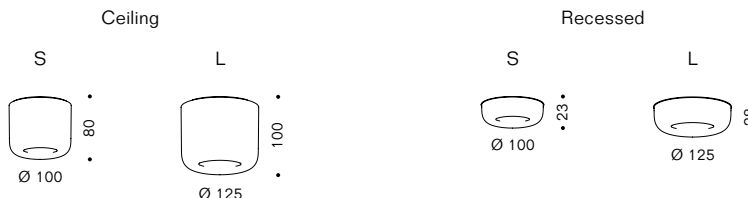

Licht
light **nach unten gerichtet, seitlich abgeschirmt**
directed downwards, shielded to the sides

Leuchtmittel
lamp LED 10–20 W, CoB, CRI Ra>95 (R9>80), EEK/EEC E

Gehäuse
housing **Aluminium schwarz oder weiß beschichtet, Aluminiumglanz finish oder Bronze finish**
aluminum black or white coated, aluminum gloss finish or bronze finish

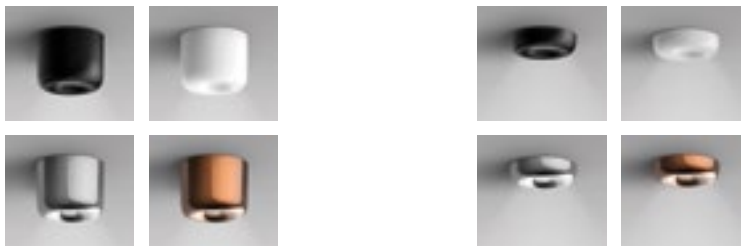

Sonstiges
features **LED wechselbar, werkzeuglose Gehäusemontage; Recessed Varianten benötigen eine Baurauhöhe oberhalb der Deckenunterkante von: S/L TRIAC >45 mm, S DALI >85 mm, L DALI >65 mm; 110 V-Varianten auf Anfrage**
LED exchangeable, housing tool-free mountable; recessed variants require an installation space above the lower edge of the ceiling of: S/L TRIAC >45 mm, S DALI >85 mm, L DALI >65 mm; 110 versions on request

CAVITY Ceiling S

Abbildung figure	Beschreibung description	Leuchtmittel lamp	Regelung control	Leistung power	CCT	Lumen lumen	Art.-Nr. art.-no.	€ netto CH excl. VAT	€ brutto CH incl. VAT
●	schwarz black	LED	TRIAC	10 W	2700 K	950 lm	CA1001	201,51 €	
					3000 K	1000 lm	CA1002	201,51 €	
○	weiß white	LED	TRIAC	10 W	2700 K	950 lm	CA1003	201,51 €	
					3000 K	1000 lm	CA1004	201,51 €	
●	Aluminiumglanz finish aluminum gloss finish	LED	TRIAC	10 W	2700 K	950 lm	CA1005	233,57 €	
					3000 K	1000 lm	CA1006	233,57 €	
●	Bronze finish bronze finish	LED	TRIAC	10 W	2700 K	950 lm	CA1007	233,57 €	
					3000 K	1000 lm	CA1008	233,57 €	

CAVITY Ceiling L

Abbildung figure	Beschreibung description	Leuchtmittel lamp	Regelung control	Leistung power	CCT	Lumen lumen	Art.-Nr. art.-no.	€ netto CH excl. VAT	€ brutto CH incl. VAT
●	schwarz black	LED	TRIAC	20 W	2700 K	1910 lm	CA2001	261,05 €	
					3000 K	2010 lm	CA2002	261,05 €	
			DALI	20 W	2700 K	1910 lm	CA2005	316,01 €	
					3000 K	2010 lm	CA2006	316,01 €	
○	weiß white	LED	TRIAC	20 W	2700 K	1910 lm	CA2007	261,05 €	
					3000 K	2010 lm	CA2008	261,05 €	
			DALI	20 W	2700 K	1910 lm	CA2011	316,01 €	
					3000 K	2010 lm	CA2012	316,01 €	
●	Aluminiumglanz finish aluminum gloss finish	LED	TRIAC	20 W	2700 K	1910 lm	CA2013	302,27 €	
					3000 K	2010 lm	CA2014	302,27 €	
			DALI	20 W	2700 K	1910 lm	CA2017	357,23 €	
					3000 K	2010 lm	CA2018	357,23 €	
●	Bronze finish bronze finish	LED	TRIAC	20 W	2700 K	1910 lm	CA2019	302,27 €	
					3000 K	2010 lm	CA2020	302,27 €	
			DALI	20 W	2700 K	1910 lm	CA2023	357,23 €	
					3000 K	2010 lm	CA2024	357,23 €	

CAVITY Recessed S

Abbildung figure	Beschreibung description	Leuchtmittel lamp	Regelung control	Leistung power	CCT	Lumen lumen	Art.-Nr. art.-no.	€ netto CH excl. VAT	€ brutto CH incl. VAT
●	schwarz black	LED	TRIAC	10 W	2700 K	1120 lm	CA1301	187,77 €	
					3000 K	1180 lm	CA1302	187,77 €	
○	weiß white	LED	TRIAC	10 W	2700 K	1120 lm	CA1303	187,77 €	
					3000 K	1180 lm	CA1304	187,77 €	
●	Aluminiumglanz finish aluminum gloss finish	LED	TRIAC	10 W	2700 K	1120 lm	CA1305	215,25 €	
					3000 K	1180 lm	CA1306	215,25 €	
●	Bronze finish bronze finish	LED	TRIAC	10 W	2700 K	1120 lm	CA1307	215,25 €	
					3000 K	1180 lm	CA1308	215,25 €	

CAVITY Recessed L

Abbildung figure	Beschreibung description	Leuchtmittel lamp	Regelung control	Leistung power	CCT	Lumen lumen	Art.-Nr. art.-no.	€ netto CH excl. VAT	€ brutto CH incl. VAT
●	schwarz black	LED	TRIAC	20 W	2700 K	1910 lm	CA2301	247,31 €	
					3000 K	2010 lm	CA2302	247,31 €	
			DALI	20 W	2700 K	1910 lm	CA2305	302,27 €	
					3000 K	2010 lm	CA2306	302,27 €	
○	weiß white	LED	TRIAC	20 W	2700 K	1910 lm	CA2307	247,31 €	
					3000 K	2010 lm	CA2308	247,31 €	
			DALI	20 W	2700 K	1910 lm	CA2311	302,27 €	
					3000 K	2010 lm	CA2312	302,27 €	
●	Aluminiumglanz finish aluminum gloss finish	LED	TRIAC	20 W	2700 K	1910 lm	CA2313	288,53 €	
					3000 K	2010 lm	CA2314	288,53 €	
			DALI	20 W	2700 K	1910 lm	CA2317	343,49 €	
					3000 K	2010 lm	CA2318	343,49 €	
●	Bronze finish bronze finish	LED	TRIAC	20 W	2700 K	1910 lm	CA2319	288,53 €	
					3000 K	2010 lm	CA2320	288,53 €	
			DALI	20 W	2700 K	1910 lm	CA2323	343,49 €	
					3000 K	2010 lm	CA2324	343,49 €	

CURLING Ceiling

Klare Formen und intelligente Gestaltungsdetails machen CURLING Ceiling zum universell einsetzbaren Downlight und Deckenlicht in einem. Das ermöglicht in jeder Raumsituation eine perfekte Lichtstimmung. CURLING Ceiling kombiniert nach unten gerichtetes Direktlicht mit sanft abstrahlendem Raumlicht. Versionen mit Acrylglasschirm in kantiger Ästhetik erweitern das Einsatzspektrum von CURLING und ermöglichen einen optimalen Einsatz in Schulen, Kindergärten, Treppenhäusern und anderen Verkehrswegen im halböffentlichen oder öffentlichen Raum.



With its clear shape and intelligent design CURLING Ceiling is an all-round downlight and ceiling light rolled into one. This allows the creation of a perfect lighting mood in any room situation. CURLING Ceiling combines light directed downward with softly diffusing ambient light. Versions with acrylic glass shade in angular aesthetics expand CURLING's range of applications and enable optimal use in schools, kindergartens, stairwells and other paths in semi-public and public spaces.

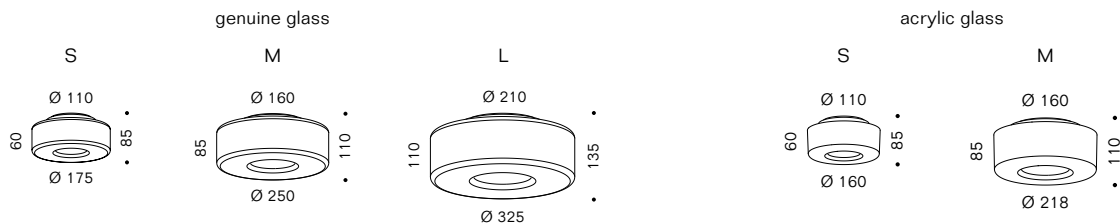

Leuchtmittel lamp LED 11–34 W, CoB, CRI Ra>97 (R9>80), EEK/EEC F (2700 K, 3000 K), G (1800–3000 K D2W)

Leuchteneinheit lighting unit Aluminium hochglanzpoliert
aluminum highly polished

Schirm shade mundgeblasenes Glas klar, opal oder metallisiert
Reflektor: Polycarbonat opal
hand-blown glass clear, opal or metallised
reflector: polycarbonate opal

Acrylglas klar
Reflektor: Polycarbonat opal
Acrylic glass clear
reflector: polycarbonate opal

Ausführungen versions



Glasschirm klar
Licht: nach unten gerichtet, rundum abstrahlend
glass shade clear
light: directed downwards, distributed all around



Acrylglasschirm klar
Licht: nach unten gerichtet, rundum abstrahlend
acrylic glass shade clear
light: directed downwards, distributed all around



Glasschirm klar, Reflektor konisch
Licht: nach unten gerichtet, rundum weich gestreut
glass shade clear, reflector conical
light: directed downwards, diffused all around



Acrylglasschirm klar, Reflektor konisch
Licht: nach unten gerichtet, rundum weich gestreut
acrylic glass shade clear, reflector conical
light: directed downwards, diffused all around



Glasschirm klar, Reflektor zylindrisch
Licht: nach unten gerichtet, rundum weich gestreut
glass shade clear, reflector cylindrical
light: directed downwards, diffused all around



Acrylglasschirm klar, Reflektor zylindrisch
Licht: nach unten gerichtet, rundum weich gestreut
acrylic glass shade clear, reflector cylindrical
light: directed downwards, diffused all around



Glasschirm opal
Licht: nach unten gerichtet, rundum weich gestreut
glass shade opal
light: directed downwards, diffused all around











Glasschirm neusilber
Licht: nach unten gerichtet, rundum abstrahlend
glass shade new silver
light: directed downwards, distributed all around

Sonstiges features LED wechselbar, werkzeuglose Schirmmontage; 110 V-Varianten auf Anfrage; Diffusorscheibe in Lieferung enthalten; DALI-Varianten für den Einsatz in Notbeleuchtungsanlagen auf Anfrage
LED exchangeable, shade tool-free mountable; 110 V versions on request; diffuser included in delivery; DALI versions for the use in emergency lighting systems on request









CURLING ist ein modularer Artikel. Bitte jeweils Leuchteneinheit und Glasschirm zusammen bestellen.
CURLING is a modular article. Please order the lighting unit and glass shade together.

☞ → 34–39 CURLING Suspension → 62 | CURLING Wall → 108





CURLING Ceiling S

Abbildung figure	Beschreibung description	Leuchtmittel lamp	Regelung control	Leistung power	CCT	Lumen lumen	Art.-Nr. art.-no.	€ netto CH € brutto CH excl. VAT incl. VAT			
	Leuchteneinheit S lighting unit S	LED	TRIAC	11 W	2700 K	1130 lm	LE015701	196,93 €			
					3000 K	1180 lm	LE015702	196,93 €			
					1800–3000 K D2W	870 lm	LE015703	233,57 €			
						DALI	11 W	2700 K	1130 lm	LE015730	224,41 €
								3000 K	1180 lm	LE015731	224,41 €
								1800–3000 K D2W	870 lm	LE015732	261,05 €
	Glas S klar glass S clear						CU014406	196,93 €			
	Glas S klar, Reflektor konisch glass S clear, reflector conical						CU014407	219,83 €			
	Glas S klar, Reflektor zylindrisch glass S clear, reflector cylindrical						CU014408	219,83 €			
	Glas S opal glass S opal						CU014405	187,77 €			
	Glas S neusilber glass S new silver						CU011201	279,37 €			
	Acrylglas S klar acrylic glass S clear						CU011203	82,44 €			
	Acrylglas S klar, Reflektor konisch acrylic glass S clear, reflector conical						CU011204	100,76 €			
	Acrylglas S klar, Reflektor zylindrisch acrylic glass S clear, reflector cylindrical						CU011205	100,76 €			

CURLING Ceiling M

Abbildung figure	Beschreibung description	Leuchtmittel lamp	Regelung control	Leistung power	CCT	Lumen lumen	Art.-Nr. art.-no.	€ netto CH € brutto CH excl. VAT incl. VAT			
	Leuchteneinheit M lighting unit M	LED	TRIAC	20 W	2700 K	1910 lm	LE015710	261,05 €			
					3000 K	2010 lm	LE015711	261,05 €			
					1800–3000 K D2W	1540 lm	LE015712	297,69 €			
						DALI 1–10 V	20 W	2700 K	1910 lm	LE015713	288,53 €
								3000 K	2010 lm	LE015714	288,53 €
								1800–3000 K D2W	1540 lm	LE015715	325,17 €
	Glas M klar glass M clear						CU014402	247,31 €			
	Glas M klar, Reflektor konisch glass M clear, reflector conical						CU014403	274,79 €			
	Glas M klar, Reflektor zylindrisch glass M clear, reflector cylindrical						CU014404	274,79 €			
	Glas M opal glass M opal						CU014401	233,57 €			
	Glas M neusilber glass M new silver						CU011202	352,65 €			
	Acrylglas M klar acrylic glass M clear						CU011206	109,92 €			
	Acrylglas M klar, Reflektor konisch acrylic glass M clear, reflector conical						CU011207	137,39 €			
	Acrylglas M klar, Reflektor zylindrisch acrylic glass M clear, reflector cylindrical						CU011208	137,39 €			

CURLING Ceiling L

Abbildung figure	Beschreibung description	Leuchtmittel lamp	Regelung control	Leistung power	CCT	Lumen lumen	Art.-Nr. art.-no.	€ netto CH excl. VAT	€ brutto CH incl. VAT
	Leuchteneinheit L lighting unit L	LED	TRIAC	34 W	2700 K	3360 lm	LE014480	316,01 €	
					3000 K	3480 lm	LE014483	316,01 €	
			DALI	34 W	2700 K	3360 lm	LE014478	343,49 €	
					3000 K	3480 lm	LE014481	343,49 €	
	Glas L klar glass L clear						CU014475	338,91 €	
	Glas L klar, Reflektor konisch glass L clear, reflector conical						CU014476	375,55 €	
	Glas L klar, Reflektor zylindrisch glass L clear, reflector cylindrical						CU014477	375,55 €	
	Glas L neusilber glass L new silver						CU014478	435,08 €	

CURLING Ceiling – Zubehör / Accessories

Optiken optics	Einfach austauschbare Optiken zur Bestimmung der Lichtverteilung von CURLING Ceiling finden Sie auf Seite 201. Easily replaceable optics to define the light distribution of CURLING Ceiling, see page 201.
--------------------------	---

REEF Ceiling

Die unverwechselbaren Leuchtschirme dieser Familie bestehen aus innovativer Schaumkeramik, deren Struktur stark an Korallen erinnert. Dabei sind sie durabel, spülmaschinentauglich und verteilen das Streulicht perfekt in einem sanften Bone China-Farbtönen. Die zylindrischen Körper sind einseitig offen – so strahlen die Leuchten dieser Familie kräftig und brillant, aber völlig blendfrei.

The unmistakable lamp shades in this family are made of innovative foam ceramic, whose texture is highly reminiscent of corals. That said they are durable, dishwasher-proof and distribute the scattered light perfectly in a gentle bone china hue. The cylindrical objects are open on one side, such that the lamps in this family shine powerfully and brightly, though without any glare at all.



reddot design award
winner 2004

DESIGN PLUS

Focus Balance
Silber

Internationaler Designpreis
Baden-Württemberg 2003

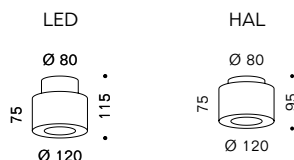

Licht light	nach unten gerichtet, rundum diffus directed downwards, diffuse all around
Leuchtmittel lamp	LED 8 W, CoB, CRI Ra>97 (R9>80), EEK/EEC F G9 max. 33 W, EEK/EEC G
Gehäuse Housing	Aluminium poliert oder gebürstet; Schirm: Keramikschaum weiß aluminium polished or brushed; shade: ceramic foam white
Sonstiges features	LED austauschbar, Schirm werkzeuglos abnehmbar und spülmaschinenfest LED exchangeable, shade tool-free removable and dishwasher safe

REEF Ceiling

Abbildung figure	Beschreibung description	Leuchtmittel lamp	Regelung control	Leistung power	CCT	Lumen lumen	Art.-Nr. art.-no.	€ netto CH excl. VAT	€ brutto CH incl. VAT
●	gebürstet brushed	LED	TRIAC	8 W	2700 K	790 lm	RF2007	366,39 €	
		G9	TRIAC	max. 33 W	2700 K	460 lm	RF1012	228,99 €	
●	poliert polished	LED	TRIAC	8 W	2700 K	790 lm	RF2009	375,55 €	
		G9	TRIAC	max. 33 W	2700 K	460 lm	RF1017	238,15 €	

DRAFT Ceiling

DRAFT Ceiling macht aus der archetypischen Kugelleuchte ein Objekt von zeitgenössischer Prägnanz und perfekt ausbalancierter Lichtwirkung. Die transparente, mundgeblasene Glaskugel und der lichtdurchlässige, mattweiße Innenreflektor treten in einen spannenden Kontrast. Das LED-Leuchtmittel tief im Inneren des konischen Reflektors sorgt rundum für weich gestreutes Raumlicht und gerichtetes Licht nach unten. Eine Diffusorscheibe gewährleistet einen besonders weichen Lichtaustritt und gleichmäßig beleuchtete Flächen. DRAFT ist absolut blendfrei, verfügt über zwei verschiedene Lichtfarben und die Dim2warm-Funktion.

DRAFT turns the archetypical spherical luminaire into an object that boasts an unpretentious contemporary look and perfectly balanced light. The transparent, hand-blown glass ball and the translucent, matte white internal reflector make for a striking contrast. Set deep in the internal reflector, the LED illuminant delivers softly diffused all-round and downward directional light. A diffuser plate ensures particularly soft light and evenly illuminated spaces. DRAFT is absolutely glare-free, comes with two different light colors and the Dim2warm function.

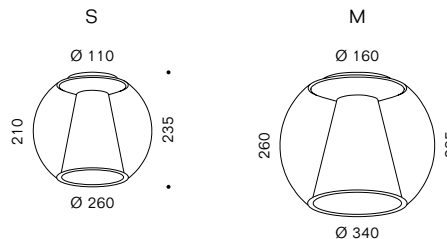

Leuchtmittel lamp	LED 11–20 W, CoB, CRI Ra>90 (R9>80), EEK/EEC F (2700 K, 3000 K), G (1800–3000 K D2W)
-----------------------------	--

Baldachin canopy	Aluminium hochglanzpoliert aluminum highly polished
----------------------------	---

Schirm shade	mundgeblasenes Glas klar, Reflektor Acrylglas opal hand-blown glass clear; reflector acrylic glass opal
------------------------	---

Ausführungen versions	Glasschirm klar, braun oder blau, Reflektor konisch opal; Licht: nach unten gerichtet, rundum weich gestreut glass shade clear, brown or blue reflector conical; light: directed downwards, diffused all around
---------------------------------	---



Sonstiges features	LED wechselbar, werkzeuglose Schirmmontage; 110 V-Varianten auf Anfrage; DALI-Varianten für den Einsatz in Notbeleuchtungsanlagen auf Anfrage LED exchangeable, shade tool-free mountable; 110 V versions on request; DALI versions for the use in emergency lighting systems on request
------------------------------	---

DRAFT ist ein modularer Artikel. Bitte jeweils Leuchteneinheit und Glasschirm zusammen bestellen.
DRAFT is a modular article. Please order the lighting unit and glass shade together.

DRAFT Ceiling S

Abbildung figure	Beschreibung description	Leuchtmittel lamp	Regelung control	Leistung power	CCT	Lumen lumen	Art.-Nr. art.-no.	€ netto CH excl. VAT	€ brutto CH incl. VAT			
	Leuchteneinheit S lighting unit S	LED	TRIAC	11 W	2700 K	1130 lm	LE015701	196,93 €				
					3000 K	1180 lm	LE015702	196,93 €				
					1800–3000 K D2W	870 lm	LE015703	233,57 €				
						DALI	11 W	2700 K	1130 lm	LE015730	224,41 €	
								3000 K	1180 lm	LE015731	224,41 €	
								1800–3000 K D2W	870 lm	LE015732	261,05 €	

	Glas S klar mit Reflektor glass S clear with reflector						DR015728	270,21 €	
---	--	--	--	--	--	--	----------	----------	--

	Glas S braun mit Reflektor glass S brown with reflector						DR015729	311,43 €	
---	---	--	--	--	--	--	----------	----------	--

	Glas S blau mit Reflektor glass S blue with reflector						DR015730	311,43 €	
---	---	--	--	--	--	--	----------	----------	--

DRAFT Ceiling M

Abbildung figure	Beschreibung description	Leuchtmittel lamp	Regelung control	Leistung power	CCT	Lumen lumen	Art.-Nr. art.-no.	€ netto CH excl. VAT	€ brutto CH incl. VAT			
	Leuchteneinheit M lighting unit M	LED	TRIAC	20 W	2700 K	1910 lm	LE015710	261,05 €				
					3000 K	2010 lm	LE015711	261,05 €				
					1800–3000 K D2W	1540 lm	LE015712	297,69 €				
					DALI	1–10 V	20 W	2700 K	1910 lm	LE015713	288,53 €	
								3000 K	2010 lm	LE015714	288,53 €	
								1800–3000 K D2W	1540 lm	LE015715	325,17 €	

	Glas M klar mit Reflektor glass M clear with reflector						DR015731	357,23 €	
---	--	--	--	--	--	--	----------	----------	--

	Glas M braun mit Reflektor glass M brown with reflector						DR015732	407,61 €	
---	---	--	--	--	--	--	----------	----------	--

	Glas M blau mit Reflektor glass M blue with reflector						DR015733	407,61 €	
---	---	--	--	--	--	--	----------	----------	--

DRUM Ceiling

Mit ihrer zylindrischen Form passt DRUM Ceiling besonders gut zu geradliniger Architektur, in den Objektbereich oder in Privaträume. Die Kegelform des opalen Innenreflektors ist jeweils abhängig von Höhe und Durchmesser der transparenten Außenform aus Glas. In der jeweiligen Kombination entsteht so ein geometrisches Spiel von klaren Zylindern und Kegeln mit verschiedenen Winkeln im Inneren. DRUM Ceiling sorgt absolut blendfrei für mildes Raumlicht und gerichtetes Licht nach unten.

With its cylindrical shape DRUM Ceiling fits perfectly into clean-cut architecture, the contract world, or private spaces. The conical shape of the opaline internal reflector depends on the height and diameter of the transparent outer body made of glass. The respective combination gives rise to a geometric interplay of clear cylinders and cones with different angles on the inside. DRUM Ceiling provides absolutely glare-free mild ambient light and light that is directed carefully downwards.

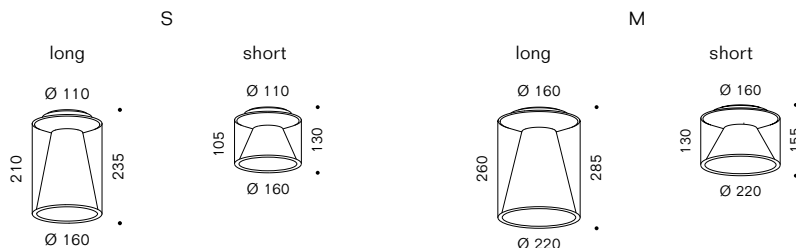

Licht
light **nach unten gerichtet, rundum weich gestreut**
directed downwards, diffused all around

Leuchtmittel
lamp LED 11–20 W, CoB, CRI Ra>90 (R9>80), EEK/EEC F (2700 K, 3000 K), G (1800–3000 K D2W)

Leuchteneinheit
lighting unit **Aluminium hochglanzpoliert**
aluminum highly polished

Glasschirm
glass shade **mundgeblasenes Glas klar, Reflektor Acrylglas opal**
hand-blown glass clear; reflector acrylic glass opal



Ausführungen
versions





Sonstiges
features **LED wechselbar, werkzeuglose Schirmmontage; 110 V-Varianten auf Anfrage;**
DALI-Varianten für den Einsatz in Notbeleuchtungsanlagen auf Anfrage
LED exchangeable, shade tool-free mountable; 110 V versions on request;
DALI versions for the use in emergency lighting systems on request

DRUM ist ein modularer Artikel. Bitte jeweils Leuchteneinheit und Glasschirm zusammen bestellen.
DRUM is a modular article. Please order the lighting unit and glass shade together.

DRUM Ceiling S

Abbildung figure	Beschreibung description	Leuchtmittel lamp	Regelung control	Leistung power	CCT	Lumen lumen	Art.-Nr. art.-no.	€ netto CH excl. VAT	€ brutto CH incl. VAT		
	Leuchteneinheit S lighting unit S	LED	TRIAC	11 W	2700 K	1130 lm	LE015701	196,93 €			
					3000 K	1180 lm	LE015702	196,93 €			
					1800–3000 K D2W	870 lm	LE015703	233,57 €			
					DALI	11 W	2700 K	1130 lm	LE015730	224,41 €	
							3000 K	1180 lm	LE015731	224,41 €	
							1800–3000 K D2W	870 lm	LE015732	261,05 €	
	Glas S long mit Reflektor glass S long with reflector						DU015801	206,09 €			
	Glas S short mit Reflektor glass S short with reflector						DU015802	155,71 €			

DRUM Ceiling M

Abbildung figure	Beschreibung description	Leuchtmittel lamp	Regelung control	Leistung power	CCT	Lumen lumen	Art.-Nr. art.-no.	€ netto CH excl. VAT	€ brutto CH incl. VAT		
	Leuchteneinheit M lighting unit M	LED	TRIAC	20 W	2700 K	1910 lm	LE015710	261,05 €			
					3000 K	2010 lm	LE015711	261,05 €			
					1800–3000 K D2W	1540 lm	LE015712	297,69 €			
					DALI 1–10 V	20 W	2700 K	1910 lm	LE015713	288,53 €	
							3000 K	2010 lm	LE015714	288,53 €	
							1800–3000 K D2W	1540 lm	LE015715	325,17 €	
	Glas M long mit Reflektor glass M long with reflector						DU015803	242,73 €			
	Glas M short mit Reflektor glass M short with reflector						DU015804	187,77 €			

POPPY Ceiling

Werden die „Mohnblüten“ dieser Familie durch Einschalten geweckt, öffnen sich ihre Schirme ganz allmählich: die feinen Blätter sind aus Bimetall und dehnen sich durch Erwärmung aus. Alle Varianten können nach Belieben umgestaltet werden. Der flexible, textilmantelte Schlauch lässt sich immer neu biegen – zur Änderung der Lichtrichtung oder einfach weil Ihnen danach ist. Die mundgeblasenen Glaskapseln sind erhältlich den Farben keramik, rubinrot oder violett.

When the “poppy flowers” in this family are woken by the lamp being switched on, their shades open very gradually: the delicate leaves are bi-metallic and expand when heated. All the versions can be reshaped as desired. The flexible, textile-coated stem can be bent at will, to change the direction of the light, or because you just feel like it. The hand-blown glass capsules are available in ceramic, ruby red or violet.

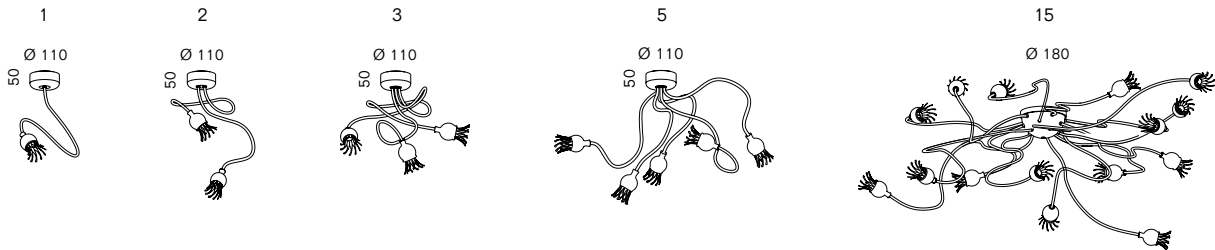







Licht light	nach vorne gerichtet, rundum dekorativ directed forward, decorative all around
Leuchtmittel lamp	POPPY Ceiling 1/2/3: 1 x/2 x/3 x G4 35 W, 12 V, EEK/EEC G POPPY Ceiling 5/15: 5 x/15 x G4 20 W, 12 V, EEK/EEC G
Größen sizes	1 bis 5 Arme: Länge der Arme 75 cm, 15 Arme: Länge der Arme 75 oder 150 cm 1 to 5 arms: length of arms 75 cm, 15 arms: length of arms 75 cm or 150 cm
Material material	Arme, flexibel: Aluminium, textilmantelt beige oder schwarz; Glasschirme: mundgeblasenes Glas in keramik, rubinrot oder violett; Lamellen: Bimetall; Baldachin: 1–5 Arme Edelstahl, poliert; 15 Arme: Edelstahl gebürstet arms, flexible: textile coated aluminium tube in beige or black; glass shade: hand-blown glass in ceramic, ruby red or violet lamellae: bimetal; canopy: 1–5 arms stainless steel, polished; 15 arms: stainless steel, brushed
Sonstiges features	Leuchtmittel in Lieferung enthalten; Reflektor-Lamellen öffnen sich nach ca. 2 Minuten Betriebszeit; Leuchte kann auch als Wandleuchte montiert werden lamps included in delivery; lamellae open within approx. 2 minutes after switching on luminaire; luminaire can also be mounted as wall luminaire







POPPY Ceiling 1

Abbildung figure	Beschreibung description	Fassung socket	Regelung control	Leistung power	Art.-Nr. art.-no.	€ netto CH excl. VAT	€ brutto CH incl. VAT
	1 Arm schwarz, Schirm keramik 1 arm black, shade ceramic	G4	ON/OFF	max. 35 W	PO1025	430,50 €	
	1 Arm schwarz, Schirm rubinrot 1 arm black, shade ruby red	G4	ON/OFF	max. 35 W	PO1026	430,50 €	
	1 Arm schwarz, Schirm violett 1 arm black, shade violet	G4	ON/OFF	max. 35 W	PO1027	430,50 €	
	1 Arm beige, Schirm keramik 1 arm beige shade ceramic	G4	ON/OFF	max. 35 W	PO1028	430,50 €	
	1 Arm beige, Schirm rubinrot 1 arm beige shade ruby red	G4	ON/OFF	max. 35 W	PO1029	430,50 €	
	1 Arm beige, Schirm violett 1 arm beige shade violet	G4	ON/OFF	max. 35 W	PO1030	430,50 €	







POPPY Ceiling 2

Abbildung figure	Beschreibung description	Fassung socket	Regelung control	Leistung power	Art.-Nr. art.-no.	€ netto CH excl. VAT	€ brutto CH incl. VAT
	2 Arme schwarz, Schirme keramik 2 arms black, shades ceramic	2 × G4	ON/OFF	max. 70 W	PO1031	540,42 €	
	2 Arme schwarz, Schirme rubinrot 2 arms black, shades ruby red	2 × G4	ON/OFF	max. 70 W	PO1032	540,42 €	
	2 Arme schwarz, Schirme violett 2 arms black, shades violet	2 × G4	ON/OFF	max. 70 W	PO1033	540,42 €	
	2 Arme beige, Schirme keramik 2 arms beige shades ceramic	2 × G4	ON/OFF	max. 70 W	PO1034	540,42 €	
	2 Arme beige, Schirme rubinrot 2 arms beige shades ruby red	2 × G4	ON/OFF	max. 70 W	PO1035	540,42 €	
	2 Arme beige, Schirme violett 2 arms beige shades violet	2 × G4	ON/OFF	max. 70 W	PO1036	540,42 €	







POPPY Ceiling 3

Abbildung figure	Beschreibung description	Fassung socket	Regelung control	Leistung power	Art.-Nr. art.-no.	€ netto CH excl. VAT	€ brutto CH incl. VAT
	3 Arme schwarz, Schirme keramik 3 arms black, shades ceramic	3 × G4	ON/OFF	max. 105 W	PO1037	650,34 €	
	3 Arme schwarz, Schirme rubinrot 3 arms black, shades ruby red	3 × G4	ON/OFF	max. 105 W	PO1038	650,34 €	
	3 Arme schwarz, Schirme violett 3 arms black, shades violet	3 × G4	ON/OFF	max. 105 W	PO1039	650,34 €	
	3 Arme beige, Schirme keramik 3 arms beige shades ceramic	3 × G4	ON/OFF	max. 105 W	PO1040	650,34 €	
	3 Arme beige, Schirme rubinrot 3 arms beige shades ruby red	3 × G4	ON/OFF	max. 105 W	PO1041	650,34 €	
	3 Arme beige, Schirme violett 3 arms beige shades violet	3 × G4	ON/OFF	max. 105 W	PO1042	650,34 €	

POPPY Ceiling 5

Abbildung figure	Beschreibung description	Fassung socket	Regelung control	Leistung power	Art.-Nr. art.-no.	€ netto CH excl. VAT	€ brutto CH incl. VAT
	5 Arme schwarz, Schirme keramik 5 arms black, shades ceramic	5 × G4	ON/OFF	max. 100 W	PO1043	842,69 €	
	5 Arme schwarz, Schirme rubinrot 5 arms black, shades ruby red	5 × G4	ON/OFF	max. 100 W	PO1044	842,69 €	
	5 Arme schwarz, Schirme violett 5 arms black, shades violet	5 × G4	ON/OFF	max. 100 W	PO1045	842,69 €	
	5 Arme beige, Schirme keramik 5 arms beige shades ceramic	5 × G4	ON/OFF	max. 100 W	PO1046	842,69 €	
	5 Arme beige, Schirme rubinrot 5 arms beige shades ruby red	5 × G4	ON/OFF	max. 100 W	PO1047	842,69 €	
	5 Arme beige, Schirme violett 5 arms beige shades violet	5 × G4	ON/OFF	max. 100 W	PO1048	842,69 €	

POPPY Ceiling 15

Abbildung figure	Beschreibung description	Fassung socket	Regelung control	Leistung power	Art.-Nr. art.-no.	€ netto CH excl. VAT	€ brutto CH incl. VAT
	15 Arme 75 cm schwarz, Schirme keramik 15 arms 75 cm black, shades ceramic	15 x G4	ON/OFF	max. 300 W	PO1007	1.923,53 €	
	15 Arme 150 cm schwarz, Schirme keramik 15 arms 150 cm black, shades ceramic	15 x G4	ON/OFF	max. 300 W	PO1010	2.015,13 €	
	15 Arme 75 cm schwarz, Schirme rubinrot 15 arms 75 cm black, shades ruby red	15 x G4	ON/OFF	max. 300 W	PO1008	1.923,53 €	
	15 Arme 150 cm schwarz, Schirme rubinrot arms 150 cm black, shades ruby red	15 x G4	ON/OFF	max. 300 W	PO1011	2.015,13 €	
	15 Arme 75 cm schwarz, Schirme violett 15 arms 75 cm black, shades violet	15 x G4	ON/OFF	max. 300 W	PO1009	1.923,53 €	
	15 Arme 150 cm schwarz, Schirme violett 15 arms 150 cm black, shades violet	15 x G4	ON/OFF	max. 300 W	PO1012	2.015,13 €	
	15 Arme 75 cm beige, Schirme keramik 15 arms 75 cm beige, shades ceramic	15 x G4	ON/OFF	max. 300 W	PO1013	1.923,53 €	
	15 Arme 150 cm beige, Schirme keramik 15 arms 150 cm beige, shades ceramic	15 x G4	ON/OFF	max. 300 W	PO1016	2.015,13 €	
	15 Arme 75 cm beige, Schirme rubinrot 15 arms 75 cm beige, shades ruby red	15 x G4	ON/OFF	max. 300 W	PO1014	1.923,53 €	
	15 Arme 150 cm beige, Schirme rubinrot 15 arms 150 cm beige, shades ruby red	15 x G4	ON/OFF	max. 300 W	PO1017	2.015,13 €	
	15 Arme 75 cm beige, Schirme violett 15 arms 75 cm beige, shades violet	15 x G4	ON/OFF	max. 300 W	PO1015	1.923,53 €	
	15 Arme 150 cm beige, Schirme violett 15 arms 150 cm beige, shades violet	15 x G4	ON/OFF	max. 300 W	PO1018	2.015,13 €	

REFLEX² Ceiling

Bei REFLEX² sorgt das auf einen eigenen Deckenreflektor strahlende Licht für eine überzeugende Lichtlösung am zentralen Deckenanschluss im Raum. REFLEX² besitzt eine feine, elegant abgerundete Rahmenstruktur, die LED-Platinen enthält. Sie strahlen auf eine Reflektorfläche im gleichen Grundmaß. REFLEX² bietet auch bei voller Leistung ein absolut blendfreies Licht, das optional per Bluetooth gesteuert werden kann. Aus einer dezenten Struktur entstehen so intensive Lichtstimmungen im Raum.



REFLEX² presents a convincing lighting solution at the central ceiling connection in a space by employing a special ceiling reflector. REFLEX² has delicate, elegantly rounded frame structure that contains the LED boards. Their light hits a reflector surface of the same basic dimensions. Even at full power, REFLEX² creates an absolutely glare-free light, whose color may further be adjusted optional via Bluetooth. As such, the subtle structure gives rise to intensive lighting moods in the space.

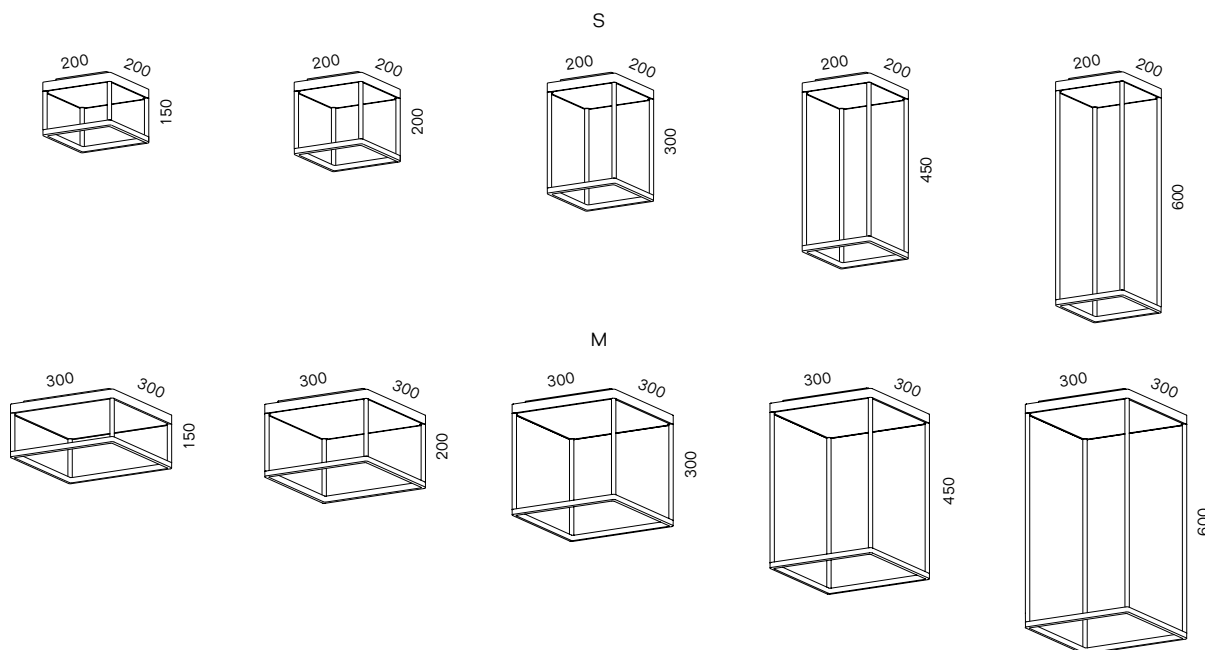

Licht
light **nach oben gestreut, indirekt über Deckenreflektor und Decke**
scattered upwards, diffuse all around due to reflector and ceiling

Leuchtmittel
lamp **LED 33–50 W, CRI Ra>90 (R9>50), EEK/EEC E**
S: 2700 K, 3000 K oder/or Dim2Warm, M: 2700 K, 3000 K oder/or 2200–4000 K/tunable white

Gehäuse
housing **Aluminium schwarz oder weiß beschichtet**
aluminium black or white coated

Material
material **Reflektor: PLEXIGLAS® Pyramidenstruktur oder PLEXIGLAS® matt; Leuchtmittelabdeckungen: Flachglas satinée**
reflector: PLEXIGLAS® pyramid structure or PLEXIGLAS® matte; lamp cover: glass semigloss

Sonstiges
features **+C kennzeichnet Produkte mit vorprogrammiertem CASAMBI-Modul in der Leuchte integriert. LED austauschbar; Einfache Montage; Reflektor einfach wechselbar; 110 V-Varianten auf Anfrage**
+C indicates products with pre-programmed CASAMBI module integrated in the luminaire.
LED exchangeable; easy assembly; reflector easily exchangeable; 110 V versions on request

REFLEX² ist ein modularer Artikel. Bitte jeweils Leuchteneinheit und Reflektor zusammen bestellen.
REFLEX² is a modular article. Please order the lamp unit and reflector together.

REFLEX² Ceiling S new versions available

Abbildung figure	Beschreibung description	Leuchtmittel lamp	Regelung control	Leistung power	CCT	Lumen lumen	Art.-Nr. art.-no.	€ netto CH excl. VAT	€ brutto CH incl. VAT			
●	150 schwarz 150 black	LED	TRIAC	33 W	2700 K new	3910 lm	RE2450	375,55 €				
					3000 K new	3960 lm	RE2451	375,55 €				
					2200–3000 K D2W	3910 lm	RE2401	416,76 €				
			DALI	33 W	2700 K new	3910 lm	RE2460	421,34 €				
					3000 K new	3960 lm	RE2461	421,34 €				
					2200–3000 K D2W	3910 lm	RE2402	462,56 €				
							2200–3000 K D2W + C	3910 lm	RE2402C	586,22 €		
			○	150 weiß 150 white	LED	TRIAC	33 W	2700 K new	3910 lm	RE2452	375,55 €	
								3000 K new	3960 lm	RE2453	375,55 €	
2200–3000 K D2W	3910 lm	RE2403						416,76 €				
DALI	33 W	2700 K new				3910 lm	RE2462	421,34 €				
		3000 K new				3960 lm	RE2463	421,34 €				
		2200–3000 K D2W				3910 lm	RE2404	462,56 €				
							2200–3000 K D2W + C	3910 lm	RE2404C	586,22 €		
●	200 schwarz 200 black	LED				TRIAC	33 W	2700 K new	3910 lm	RE2550	375,55 €	
								3000 K new	3960 lm	RE2551	375,55 €	
			2200–3000 K D2W	3910 lm	RE2501			416,76 €				
			DALI	33 W	2700 K new	3910 lm	RE2560	421,34 €				
					3000 K new	3960 lm	RE2561	421,34 €				
					2200–3000 K D2W	3910 lm	RE2502	462,56 €				
							2200–3000 K D2W + C	3910 lm	RE2502C	586,22 €		
			○	200 weiß 200 white	LED	TRIAC	33 W	2700 K new	3910 lm	RE2552	375,55 €	
								3000 K new	3960 lm	RE2553	375,55 €	
2200–3000 K D2W	3910 lm	RE2503						416,76 €				
DALI	33 W	2700 K new				3910 lm	RE2562	421,34 €				
		3000 K new				3960 lm	RE2563	421,34 €				
		2200–3000 K D2W				3910 lm	RE2504	462,56 €				
							2200–3000 K D2W + C	3910 lm	RE2504C	586,22 €		
●	300 schwarz 300 black	LED				TRIAC	33 W	2700 K new	3910 lm	RE2650	375,55 €	
								3000 K new	3960 lm	RE2651	375,55 €	
			2200–3000 K D2W	3910 lm	RE2601			416,76 €				
			DALI	33 W	2700 K new	3910 lm	RE2660	421,34 €				
					3000 K new	3960 lm	RE2661	421,34 €				
					2200–3000 K D2W	3910 lm	RE2602	462,56 €				
							2200–3000 K D2W + C	3910 lm	RE2602C	586,22 €		
			○	300 weiß 300 white	LED	TRIAC	33 W	2700 K new	3910 lm	RE2652	375,55 €	
								3000 K new	3960 lm	RE2653	375,55 €	
2200–3000 K D2W	3910 lm	RE2603						416,76 €				
DALI	33 W	2700 K new				3910 lm	RE2662	421,34 €				
		3000 K new				3960 lm	RE2663	421,34 €				
		2200–3000 K D2W				3910 lm	RE2604	462,56 €				
							2200–3000 K D2W + C	3910 lm	RE2604C	586,22 €		

REFLEX² Ceiling S new versions available

Abbildung figure	Beschreibung description	Leuchtmittel lamp	Regelung control	Leistung power	CCT	Lumen lumen	Art.-Nr. art.-no.	€ netto CH excl. VAT	€ brutto CH incl. VAT
●	450 schwarz 450 black	LED	TRIAC	33 W	2700 K new	3910 lm	RE2750	375,55 €	
					3000 K new	3960 lm	RE2751	375,55 €	
					2200–3000 K D2W	3910 lm	RE2701	416,76 €	
			DALI	33 W	2700 K new	3910 lm	RE2760	421,34 €	
					3000 K new	3960 lm	RE2761	421,34 €	
					2200–3000 K D2W	3910 lm	RE2702	462,56 €	
				2200–3000 K D2W + C	3910 lm	RE2702C	586,22 €		
○	450 weiß 450 white	LED	TRIAC	33 W	2700 K new	3910 lm	RE2752	375,55 €	
					3000 K new	3960 lm	RE2753	375,55 €	
					2200–3000 K D2W	3910 lm	RE2703	416,76 €	
			DALI	33 W	2700 K new	3910 lm	RE2762	421,34 €	
					3000 K new	3960 lm	RE2763	421,34 €	
					2200–3000 K D2W	3910 lm	RE2704	462,56 €	
				2200–3000 K D2W + C	3910 lm	RE2704C	586,22 €		
●	600 schwarz 600 black	LED	TRIAC	33 W	2700 K new	3910 lm	RE2950	375,55 €	
					3000 K new	3960 lm	RE2951	375,55 €	
					2200–3000 K D2W	3910 lm	RE2901	416,76 €	
			DALI	33 W	2700 K new	3910 lm	RE2960	421,34 €	
					3000 K new	3960 lm	RE2961	421,34 €	
					2200–3000 K D2W	3910 lm	RE2902	462,56 €	
				2200–3000 K D2W + C	3910 lm	RE2902C	586,22 €		
○	600 weiß 600 white	LED	TRIAC	33 W	2700 K new	3910 lm	RE2952	375,55 €	
					3000 K new	3960 lm	RE2953	375,55 €	
					2200–3000 K D2W	3910 lm	RE2903	416,76 €	
			DALI	33 W	2700 K new	3910 lm	RE2962	421,34 €	
					3000 K new	3960 lm	RE2963	421,34 €	
					2200–3000 K D2W	3910 lm	RE2904	462,56 €	
				2200–3000 K D2W + C	3910 lm	RE2904C	586,22 €		

REFLEX² Ceiling S Reflektor

Abbildung figure	Beschreibung description	Art.-Nr. art.-no.	€ netto CH excl. VAT	€ brutto CH incl. VAT
○	Pyramidenstruktur weiß pyramid structure white	RE3051	91,60 €	
●	Pyramidenstruktur silber pyramid structure silver	RE3052	91,60 €	
●	Pyramidenstruktur gold pyramid structure gold	RE3053	91,60 €	
○	matt weiß matte white	RE3054	91,60 €	

REFLEX² Ceiling M

Abbildung figure	Beschreibung description	Leuchtmittel lamp	Regelung control	Leistung power	CCT	Lumen lumen	Art.-Nr. art.-no.	€ netto CH excl. VAT	€ brutto CH incl. VAT
●	150 schwarz 150 black	LED	TRIAC 0-10 V	40 W	2700 K	4900 lm	RE2001	572,48 €	
					3000 K	5000 lm	RE2002	572,48 €	
			DALI	50 W	2700 K	5700 lm	RE2003	622,86 €	
					3000 K	5800 lm	RE2004	622,86 €	
					2200-4000 K TW	6040 lm	RE2005	719,03 €	
					2200-4000 K TW + C	6040 lm	RE2005C	856,43 €	
○	150 weiß 150 white	LED	TRIAC 0-10 V	40 W	2700 K	4900 lm	RE2006	572,48 €	
					3000 K	5000 lm	RE2007	572,48 €	
			DALI	50 W	2700 K	5700 lm	RE2008	622,86 €	
					3000 K	5800 lm	RE2009	622,86 €	
					2200-4000 K TW	6040 lm	RE2010	719,03 €	
					2200-4000 K TW + C	6040 lm	RE2010C	856,43 €	
●	200 schwarz 200 black	LED	TRIAC 0-10 V	40 W	2700 K	4900 lm	RE2801	572,48 €	
					3000 K	5000 lm	RE2802	572,48 €	
			DALI	50 W	2700 K	5700 lm	RE2803	622,86 €	
					3000 K	5800 lm	RE2804	622,86 €	
					2200-4000 K TW	6040 lm	RE2805	719,03 €	
					2200-4000 K TW + C	6040 lm	RE2805C	856,43 €	
○	200 weiß 200 white	LED	TRIAC 0-10 V	40 W	2700 K	4900 lm	RE2806	572,48 €	
					3000 K	5000 lm	RE2807	572,48 €	
			DALI	50 W	2700 K	5700 lm	RE2808	622,86 €	
					3000 K	5800 lm	RE2809	622,86 €	
					2200-4000 K TW	6040 lm	RE2810	719,03 €	
					2200-4000 K TW + C	6040 lm	RE2810C	856,43 €	
●	300 schwarz 300 black	LED	TRIAC 0-10 V	40 W	2700 K	4900 lm	RE2101	572,48 €	
					3000 K	5000 lm	RE2102	572,48 €	
			DALI	50 W	2700 K	5700 lm	RE2103	622,86 €	
					3000 K	5800 lm	RE2104	622,86 €	
					2200-4000 K TW	6040 lm	RE2105	719,03 €	
					2200-4000 K TW + C	6040 lm	RE2105C	856,43 €	
○	300 weiß 300 white	LED	TRIAC 0-10 V	40 W	2700 K	4900 lm	RE2106	572,48 €	
					3000 K	5000 lm	RE2107	572,48 €	
			DALI	50 W	2700 K	5700 lm	RE2108	622,86 €	
					3000 K	5800 lm	RE2109	622,86 €	
					2200-4000 K TW	6040 lm	RE2110	719,03 €	
					2200-4000 K TW + C	6040 lm	RE2110C	856,43 €	
●	450 schwarz 450 black	LED	TRIAC 0-10 V	40 W	2700 K	4900 lm	RE2201	572,48 €	
					3000 K	5000 lm	RE2202	572,48 €	
			DALI	50 W	2700 K	5700 lm	RE2203	622,86 €	
					3000 K	5800 lm	RE2204	622,86 €	
					2200-4000 K TW	6040 lm	RE2205	719,03 €	
					2200-4000 K TW + C	6040 lm	RE2205C	856,43 €	
○	450 weiß 450 white	LED	TRIAC 0-10 V	40 W	2700 K	4900 lm	RE2206	572,48 €	
					3000 K	5000 lm	RE2207	572,48 €	
			DALI	50 W	2700 K	5700 lm	RE2208	622,86 €	
					3000 K	5800 lm	RE2209	622,86 €	
					2200-4000 K TW	6040 lm	RE2210	719,03 €	
					2200-4000 K TW + C	6040 lm	RE2210C	856,43 €	

Abbildung figure	Beschreibung description	Leuchtmittel lamp	Regelung control	Leistung power	CCT	Lumen lumen	Art.-Nr. art.-no.	€ netto CH excl. VAT	€ brutto CH incl. VAT
●	600 schwarz 600 black	LED	TRIAC 0–10 V	40 W	2700 K	4900 lm	RE2301	572,48 €	
					3000 K	5000 lm	RE2302	572,48 €	
				2700 K	5700 lm	RE2303	622,86 €		
			DALI	50 W	3000 K	5800 lm	RE2304	622,86 €	
					2200–4000 K TW	6040 lm	RE2305	719,03 €	
					2200–4000 K TW + C	6040 lm	RE2305C	856,43 €	
○	600 weiß 600 white	LED	TRIAC 0–10 V	40 W	2700 K	4900 lm	RE2306	572,48 €	
					3000 K	5000 lm	RE2307	572,48 €	
				2700 K	5700 lm	RE2308	622,86 €		
			DALI	50 W	3000 K	5800 lm	RE2309	622,86 €	
					2200–4000 K TW	6040 lm	RE2310	719,03 €	
					2200–4000 K TW + C	6040 lm	RE2310C	856,43 €	

REFLEX² Ceiling M Reflektor

Abbildung figure	Beschreibung description	Art.-Nr. art.-no.	€ netto CH excl. VAT	€ brutto CH incl. VAT
○	Pyramidenstruktur weiß pyramid structure white	RE3001	105,34 €	
●	Pyramidenstruktur silber pyramid structure silver	RE3002	105,34 €	
●	Pyramidenstruktur gold pyramid structure gold	RE3003	105,34 €	
○	matt weiß matte white	RE3004	105,34 €	

SLICE² PI Ceiling

Mit dem Kreis als perfekte Form bietet die Deckenleuchte SLICE² PI Ceiling die universelle Lichtlösung für alle Anforderungen moderner Architektur hinsichtlich Lichtleistung und Ausleuchtung. Ideales, blendfreies Licht wird seitlich über die Glaskante eingespeist und von einer mikroprismatischen Scheibe nach unten verteilt – Wahlweise mit zusätzlichem Indirektlicht zur Deckenaufhellung. Das komplett geschlossene Gehäuse, die Echtglasscheibe und der robuste Aluminiumring sind von substanzieller Qualität. Durch die einfache Montage mittels Bajonettverschluss, der sowohl mechanischen als auch elektrischen Kontakt herstellt, lassen sich problemlos auch große Projekte realisieren.



With the circle as the perfect shape, the SLICE² PI Ceiling luminaire offers the universal lighting solution for all requirements of modern architecture in terms of light output and illumination. Ideal, glare-free downward light is fed in laterally via the edge of the glass and distributed downward by a microprismatic pane – optionally with additional indirect light to lighten up the ceiling. The completely enclosed housing, the real glass pane and the robust aluminum ring are of substantial quality. Simple mounting by means of a bayonet catch, that establishes both mechanical and electrical contact, makes it easy to realise even large projects.

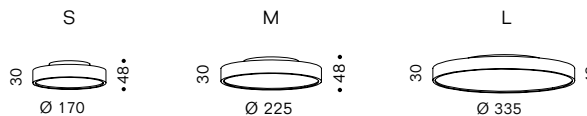

Licht light	nach unten entblendet durch Mikroprismen-Strukturglas, optional nach oben dezent diffus, UGR<19 downward glare-reduced by micro-prismatic structural glass; optional upward subtly diffused, UGR<19
-----------------------	--

Leuchtmittel lamp	LED 10/13/20 W, CRI Ra>95, EEK/EEC D (2700 K), C (3000 K)
-----------------------------	---







Gehäuse housing	Aluminium schwarz oder weiß beschichtet, Aluminium glanzverchromt aluminum black or white coated, aluminum chrome plated
---------------------------	--

Material material	Baldachin: opales Spritzgussgehäuse; Abdeckung Acrylglas Diffusor; Leuchteneinheit: Prismenstruktur-Acrylglas mit abschließender Echtglasscheibe canopy: injection moulded housing opal, cover acrylic diffuser; lighting unit: prismatic structured acrylic glass sealed by real glass pane
-----------------------------	---









Sonstiges features	einfache Montage durch Bajonettverschluss easy assembly through bayonet lock
------------------------------	--







SLICE² PI Ceiling S

Abbildung figure	Beschreibung description	Leuchtmittel lamp	Regelung control	Leistung power	CCT	Lumen lumen	Art.-Nr. art.-no.	€ netto CH excl. VAT	€ brutto CH incl. VAT
	Treibereinheit S driver unit S		TRIAC	13 W			DE011001	73,28 €	
			DALI	10 W			DE011002	91,60 €	
● 	Gehäuse S schwarz housing S black	LED			2700 K	1460 lm	PI1001	261,05 €	
					3000 K	1500 lm	PI1002	261,05 €	
● 	Gehäuse S schwarz, mit Indirektlicht housing S black, with indirect light	LED			2700 K	1460 lm	PI1011	261,05 €	
					3000 K	1500 lm	PI1012	261,05 €	
○ 	Gehäuse S weiß housing S white	LED			2700 K	1460 lm	PI1021	261,05 €	
					3000 K	1500 lm	PI1022	261,05 €	
○ 	Gehäuse S weiß, mit Indirektlicht housing S white, with indirect light	LED			2700 K	1460 lm	PI1031	261,05 €	
					3000 K	1500 lm	PI1032	261,05 €	
● 	Gehäuse S glanzverchromt housing S chrome-plated	LED			2700 K	1460 lm	PI1041	297,69 €	
					3000 K	1500 lm	PI1042	297,69 €	
● 	Gehäuse S glanzverchromt, mit Indirektlicht housing S chrome-plated, with indirect light	LED			2700 K	1460 lm	PI1051	297,69 €	
					3000 K	1500 lm	PI1052	297,69 €	

SLICE² PI Ceiling M

Abbildung figure	Beschreibung description	Leuchtmittel lamp	Regelung control	Leistung power	CCT	Lumen lumen	Art.-Nr. art.-no.	€ netto CH excl. VAT	€ brutto CH incl. VAT
	Treibereinheit M driver unit M		TRIAC	16 W			DE011011	87,02 €	
			DALI	15 W			DE011012	123,66 €	
● 	Gehäuse M schwarz housing M black	LED			2700 K	1940 lm	PI1101	357,23 €	
					3000 K	2000 lm	PI1102	357,23 €	
● 	Gehäuse M schwarz, mit Indirektlicht housing M black, with indirect light	LED			2700 K	1940 lm	PI1111	357,23 €	
					3000 K	2000 lm	PI1112	357,23 €	
○ 	Gehäuse M weiß housing M white	LED			2700 K	1940 lm	PI1121	357,23 €	
					3000 K	2000 lm	PI1122	357,23 €	
○ 	Gehäuse M weiß, mit Indirektlicht housing M white, with indirect light	LED			2700 K	1940 lm	PI1131	357,23 €	
					3000 K	2000 lm	PI1132	357,23 €	
● 	Gehäuse M glanzverchromt housing M chrome-plated	LED			2700 K	1940 lm	PI1141	403,03 €	
					3000 K	2000 lm	PI1142	403,03 €	
● 	Gehäuse M glanzverchromt, mit Indirektlicht housing M chrome-plated, with indirect light	LED			2700 K	1940 lm	PI1151	403,03 €	
					3000 K	2000 lm	PI1152	403,03 €	

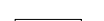
SLICE² PI Ceiling L

Abbildung figure	Beschreibung description	Leuchtmittel lamp	Regelung control	Leistung power	CCT	Lumen lumen	Art.-Nr. art.-no.	€ netto CH excl. VAT	€ brutto CH incl. VAT
	Treibereinheit L driver unit L		TRIAC	23 W			DE011021	114,50 €	
			DALI	23 W			DE011022	155,71 €	
● 	Gehäuse L schwarz housing L black	LED			2700 K	2910 lm	PI1201	485,46 €	
					3000 K	3000 lm	PI1202	485,46 €	
● 	Gehäuse L schwarz, mit Indirektlicht housing L black, with indirect light	LED			2700 K	2910 lm	PI1211	485,46 €	
					3000 K	3000 lm	PI1212	485,46 €	
○ 	Gehäuse L weiß housing L white	LED			2700 K	2910 lm	PI1221	485,46 €	
					3000 K	3000 lm	PI1222	485,46 €	
○ 	Gehäuse L weiß, mit Indirektlicht housing L white, with indirect light	LED			2700 K	2910 lm	PI1231	485,46 €	
					3000 K	3000 lm	PI1232	485,46 €	
● 	Gehäuse L glanzverchromt housing L chrome-plated	LED			2700 K	2910 lm	PI1241	549,58 €	
					3000 K	3000 lm	PI1242	549,58 €	
● 	Gehäuse L glanzverchromt, mit Indirektlicht housing L chrome-plated, with indirect light	LED			2700 K	2910 lm	PI1251	549,58 €	
					3000 K	3000 lm	PI1252	549,58 €	

ANNEX Ceiling L
reflector: opal glass



ANNEX Ceiling M
reflector: opal glass



ANNEX Ceiling S
reflector: opal glass



ANNEX Ceiling L
reflector: polished aluminum



ANNEX Ceiling M
reflector: polished aluminum



ANNEX Ceiling S
reflector: polished aluminum



ANNEX Ceiling L
reflector: crystal glass



ANNEX Ceiling M
reflector: crystal glass



ANNEX Ceiling S
reflector: crystal glass















CAVITY Ceiling | CAVITY Recessed • black



CAVITY Ceiling | CAVITY Recessed • white





CAVITY Ceiling | CAVITY Recessed • aluminium gloss finish



CAVITY Ceiling | CAVITY Recessed • bronze finish





shade: glass clear
reflector: conical opal



shade: glass clear
reflector: cylindrical opal



shade: glass clear



shade: acrylic glass clear
reflector: conical opal



shade: acrylic glass clear
reflector: cylindrical opal



shade: acrylic glass clear













DRAFT Ceiling M • clear



DRAFT Ceiling S • clear



DRAFT Ceiling M • brown



DRAFT Ceiling S • brown



DRAFT Ceiling M • blue



DRAFT Ceiling S • blue





DRUM Ceiling M • long



DRUM Ceiling S • long



DRUM Ceiling M • short



DRUM Ceiling S • short











REEF Ceiling • brushed



CEILING

REEF Ceiling • brushed





reflector: pyramid white



reflector: pyramid silver



reflector: pyramid gold

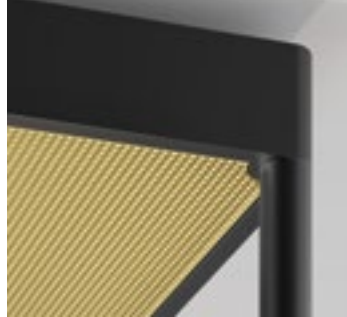

reflector: matte white













SLICE² PI Ceiling L · black



SLICE² PI Ceiling M · black



SLICE² PI Ceiling S · black



SLICE² PI Ceiling L · white



SLICE² PI Ceiling M · white



SLICE² PI Ceiling S · white



SLICE² PI Ceiling L · chrome



SLICE² PI Ceiling M · chrome



SLICE² PI Ceiling S · chrome







ANNEX
S. 58

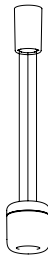

CAVITY
S. 60



CURLING
S. 62



DRAFT
S. 66



DRUM
S. 68

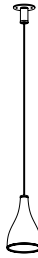

ONE EIGHTY
S. 70

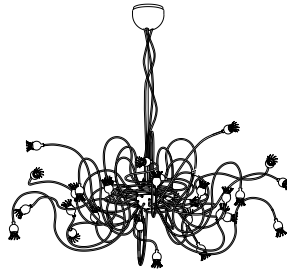

POPPY
S. 72

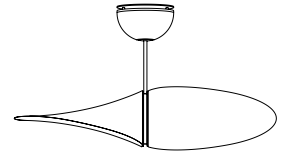

PROPELLER
S. 73

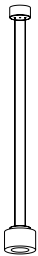

REEF
S. 74

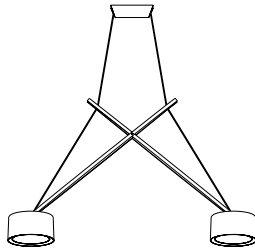

TWIN
S. 75

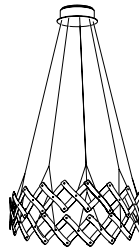

ZOOM
S. 76

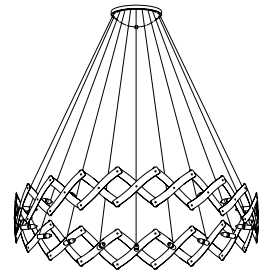

ZOOM XL
S. 76

ANNEX Suspension

Eine geradezu archetypische Deckenleuchte mit dem Mehr an Funktionalität, auf das wir Wert legen: drei verschiedene Größen korrespondieren mit den Proportionen Ihrer Räume. Mit den unterschiedlichen Reflektoren im Innern des mundgeblasenen Kegelschirms lassen sich äußerst differenzierte Lichtwirkungen erzielen, die formal dennoch einer Familie angehören.

An almost archetypal ceiling light with more functionality that we value: three different sizes correspond with the proportions of your rooms. The different reflectors inside the hand-blown cone shade make it possible to achieve extremely differentiated lighting effects that formally belong to a family.



DESIGN PLUS

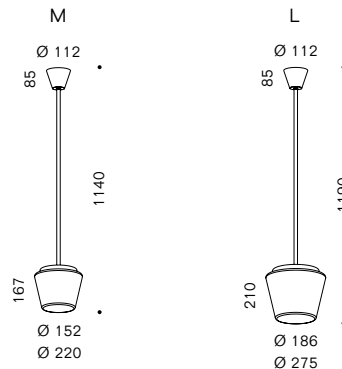

Leuchtmittel
lamp LED 20–41 W, CoB, CRI Ra>97 (R9>80), EEK/EEC E (3000 K), F (2700 K)

Leuchteneinheit
light unit **Aluminium, hochglanzpoliert und weiß beschichtet**
aluminum, highly polished and coated white

Schirm
shade **mundgeblasenes Glas klar**
hand-blown glass clear

Abhängung
suspension **Stahlrohr verchromt**
chromed steel tube

Ausführungen
versions



Glasschirm klar, Reflektor Acrylglas opal
Licht: nach unten gerichtet, rundum gestreut
glass shade clear, reflector acrylic glass opal
light: directed downwards, distributed all around





Glasschirm klar, Reflektor Aluminium poliert
Licht: nach unten gerichtet, rundum diffus
glass shade clear, reflector: aluminium polished
light: directed downwards, diffused all around





Glasschirm klar, Reflektor Kristallglas geschliffen mit Aluminium-Innenreflektor
Licht: nach unten gerichtet, rundum dekorativ
glass shade clear, reflector crystal glass with aluminium reflector cut crystal glass
light: directed downwards, diffused all around

Sonstiges
features **LED austauschbar; werkzeuglose Schirmmontage; 110 V-Varianten auf Anfrage**
LED exchangeable; glass shade tool-free mountable; 110 V versions on request

ANNEX Suspension M

Abbildung figure	Beschreibung description	Leuchtmittel lamp	Regelung control	Leistung power	CCT	Lumen lumen	Art.-Nr. art.-no.	€ netto CH excl. VAT	€ brutto CH incl. VAT
	Reflektor opal reflector opal	LED	TRIAC	20 W	2700 K	1450 lm	AN3101	664,08 €	
					3000 K	1500 lm	AN3102	664,08 €	
			DALI	27 W	2700 K	2900 lm	AN3105	700,71 €	
					3000 K	3000 lm	AN3106	700,71 €	
	Reflektor poliert reflector polished	LED	TRIAC	20 W	2700 K	1450 lm	AN3111	700,71 €	
					3000 K	1500 lm	AN3112	700,71 €	
			DALI	27 W	2700 K	2900 lm	AN3116	737,35 €	
					3000 K	3000 lm	AN3117	737,35 €	
	Reflektor Kristall reflector crystal	LED	TRIAC	20 W	2700 K	1450 lm	AN3121	815,21 €	
					3000 K	1500 lm	AN3122	815,21 €	
			DALI	27 W	2700 K	2900 lm	AN3125	851,85 €	
					3000 K	3000 lm	AN3126	851,85 €	

ANNEX Suspension L

Abbildung figure	Beschreibung description	Leuchtmittel lamp	Regelung control	Leistung power	CCT	Lumen lumen	Art.-Nr. art.-no.	€ netto CH excl. VAT	€ brutto CH incl. VAT
	Reflektor opal reflector opal	LED	TRIAC	34 W	2700 K	3850 lm	AN3147	741,93 €	
					3000 K	4010 lm	AN3148	741,93 €	
			DALI	41 W	2700 K	4500 lm	AN3151	787,73 €	
					3000 K	4680 lm	AN3152	787,73 €	
	Reflektor poliert reflector polished	LED	TRIAC	34 W	2700 K	3850 lm	AN3153	787,73 €	
					3000 K	4010 lm	AN3154	787,73 €	
			DALI	41 W	2700 K	4500 lm	AN3157	833,53 €	
					3000 K	4680 lm	AN3158	833,53 €	
	Reflektor Kristall reflector crystal	LED	TRIAC	34 W	2700 K	3850 lm	AN3141	961,76 €	
					3000 K	4010 lm	AN3142	961,76 €	
			DALI	41 W	2700 K	4500 lm	AN3145	1.007,56 €	
					3000 K	4680 lm	AN3146	1.007,56 €	

CAVITY Suspension

Ein speziell konzipierter, kurvenförmiger Aluminiumkörper mit vertieft sitzendem Leuchtmittel ersetzt beim Strahler CAVITY den Reflektor und erlaubt eine freie Entfaltung des Lichts, das über die Trichterform scheinbar nach außen fließt. Es entsteht ein Downlight mit einem blendfreien und sanften Licht, das aus jedem Winkel angenehm wirkt. Unterschiedliche Beleuchtungsaufgaben können einheitlich durch Kombination der Wandleuchten mit Aufbau- und Einbaustrahlern sowie den Pendelleuchten dieser Produktfamilie gelöst werden.

A specially designed, curved aluminum body including the recessed illuminant replaces the reflector in spotlight CAVITY and allows the light to unfold freely, seemingly flowing outwards via the funnel shaped form. The result is a glare-free and soft downlight, that is pleasant from all angles. Different lighting tasks can be solved consistently by combining the wall luminaires with surface-mounted and recessed spotlights and the pendant luminaires of this product family.

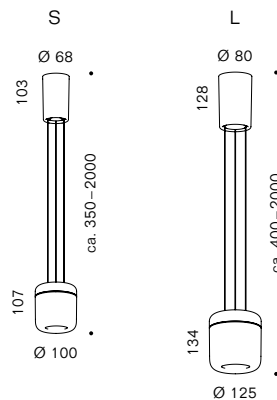

Licht
light **nach unten gerichtet, seitlich abgeschirmt**
directed downwards, shielded to the sides

Leuchtmittel
lamp LED 12–20 W, CoB, CRI Ra>95 (R9>80), EEK/EEC E

Gehäuse
housing **Aluminium schwarz oder weiß beschichtet, Aluminiumglanz finish oder Bronze finish**
aluminum black or white coated, aluminum gloss finish or bronze finish



Sonstiges
features **LED austauschbar, werkzeuglose Gehäusemontage; geeignet für Deckenhöhen bis 3 m, Sonderlängen und 110 V-Varianten auf Anfrage**
LED exchangeable; housing tool-free mountable; suitable for ceiling heights up to 3 m, special lengths and 110 V versions on request

CAVITY Suspension S

Abbildung figure	Beschreibung description	Leuchtmittel lamp	Regelung control	Leistung power	CCT	Lumen lumen	Art.-Nr. art.-no.	€ netto CH excl. VAT	€ brutto CH incl. VAT
●	schwarz black	LED	TRIAC	12 W	2700 K	1220 lm	CA1101	357,23 €	
					3000 K	1280 lm	CA1102	357,23 €	
○	weiß white	LED	TRIAC	12 W	2700 K	1220 lm	CA1103	357,23 €	
					3000 K	1280 lm	CA1104	357,23 €	
●	Aluminiumglanz finish aluminum gloss finish	LED	TRIAC	12 W	2700 K	1220 lm	CA1105	430,50 €	
					3000 K	1280 lm	CA1106	430,50 €	
●	Bronze finish bronze finish	LED	TRIAC	12 W	2700 K	1220 lm	CA1107	430,50 €	
					3000 K	1280 lm	CA1108	430,50 €	

CAVITY Suspension L

Abbildung figure	Beschreibung description	Leuchtmittel lamp	Regelung control	Leistung power	CCT	Lumen lumen	Art.-Nr. art.-no.	€ netto CH excl. VAT	€ brutto CH incl. VAT
●	schwarz black	LED	TRIAC	20 W	2700 K	2070 lm	CA2101	499,20 €	
					3000 K	2140 lm	CA2102	499,20 €	
			DALI	20 W	2700 K	2070 lm	CA2105	558,74 €	
					3000 K	2140 lm	CA2106	558,74 €	
○	weiß white	LED	TRIAC	20 W	2700 K	2070 lm	CA2107	499,20 €	
					3000 K	2140 lm	CA2108	499,20 €	
			DALI	20 W	2700 K	2070 lm	CA2111	558,74 €	
					3000 K	2140 lm	CA2112	558,74 €	
●	Aluminiumglanz finish aluminum gloss finish	LED	TRIAC	20 W	2700 K	2070 lm	CA2113	595,38 €	
					3000 K	2140 lm	CA2114	595,38 €	
			DALI	20 W	2700 K	2070 lm	CA2117	654,92 €	
					3000 K	2140 lm	CA2118	654,92 €	
●	Bronze finish bronze finish	LED	TRIAC	20 W	2700 K	2070 lm	CA2119	595,38 €	
					3000 K	2140 lm	CA2120	595,38 €	
			DALI	20 W	2700 K	2070 lm	CA2123	654,92 €	
					3000 K	2140 lm	CA2124	654,92 €	

CAVITY Suspension L – Zubehör / Accessories

Baldachinprofil
Canopy profiles

Baldachine für die Montage von 2 oder 3 CAVITY Suspension L an einem Deckenauslass finden Sie auf den Seiten 198–199.
Canopies for mounting 2 or 3 CAVITY Suspension L on one ceiling outlet can be found on pages 198–199.

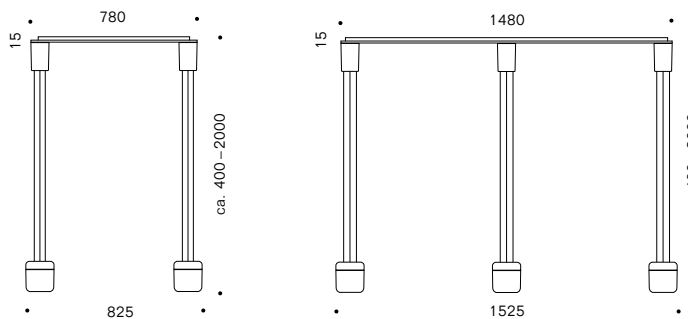

CAVITY Suspension L

CURLING Suspension







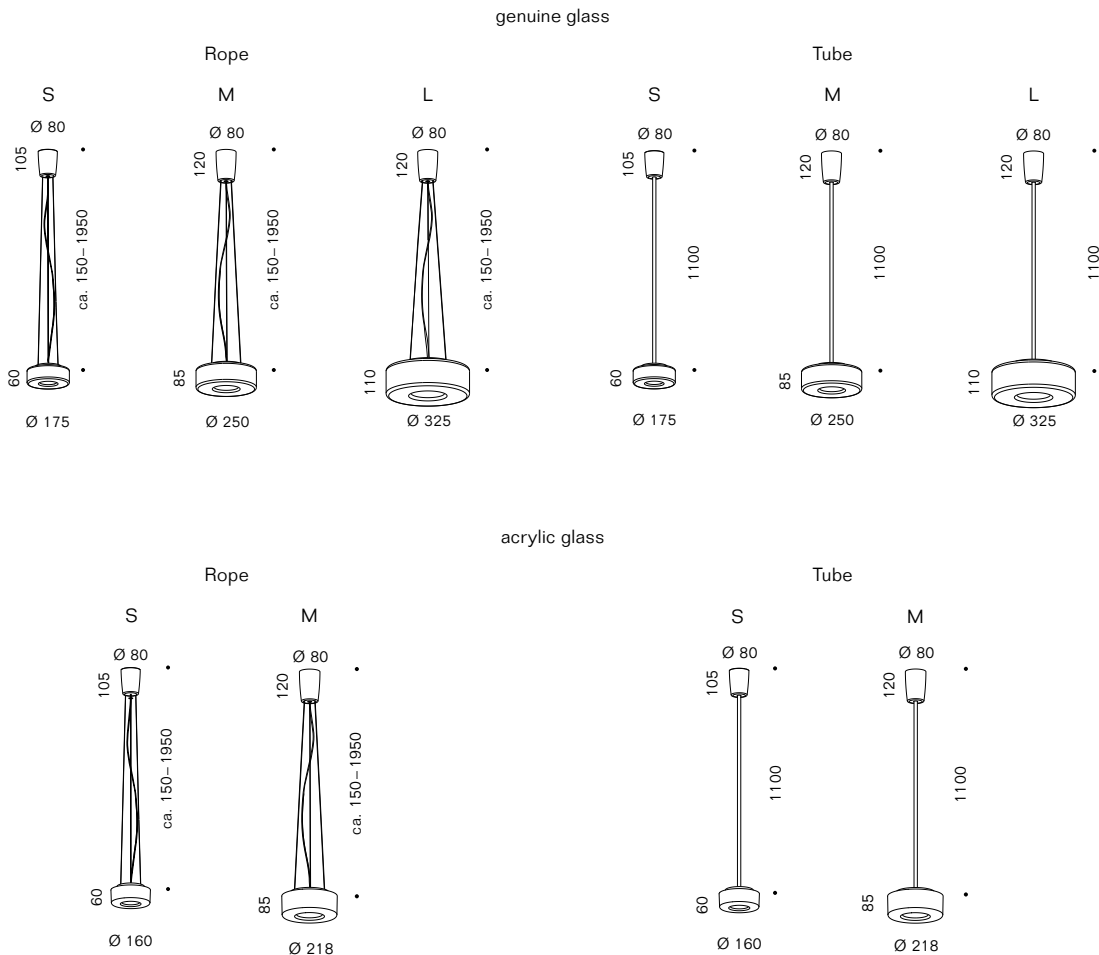

Klare Formen und intelligente Gestaltungsdetails machen CURLING Suspension zum universell einsetzbaren Downlight und Raumlicht in einem. Das ermöglicht besonders bei hohen Decken für jede Raumsituation und jede Raumhöhe die perfekte Lichtstimmung. CURLING Suspension kombiniert nach unten gerichtetes Direktlicht mit sanftem Raumlicht. Versionen mit Acrylglasschirm in kantiger Ästhetik erweitert das Einsatzspektrum von CURLING und ermöglichen einen optimalen Einsatz in Schulen, Kindergärten, Treppenhäusern und anderen Verkehrswegen im halböffentlichen oder öffentlichen Raum.



With its clear shape and intelligent design CURLING Suspension is an all-round downlight and ceiling light rolled into one. This means that in any setting you can rely on the perfect light mood. CURLING Suspension combines light directed downward with softly diffusing ambient light. Versions with acrylic glass shade in angular aesthetics expand CURLING's range of applications and enable optimal use in schools, kindergartens, stairwells and other paths in semi-public and public spaces.



Leuchtmittel lamp	LED 11–34 W, CoB, CRI Ra>97 (R9>80), EEK/EEC F (2700 K, 3000 K), G (1800–3000 K D2W)
Leuchteneinheit light unit	Aluminium hochglanzpoliert aluminum highly polished
Abhängung suspension	Edelstahlseil oder Stahlrohr verchromt stainless steel rope or chromed steel tube

Schirm shade	mundgeblasenes Glas klar, opal oder metallisiert Reflektor: Polycarbonat opal mundgeblasenes Glas klar, opal oder metallisiert Reflektor: Polycarbonat opal	Acrylglas klar Reflektor: Polycarbonat opal Acrylic glass clear reflector: polycarbonate opal
Ausführungen versions	 Glasschirm klar Licht: nach unten gerichtet, rundum abstrahlend glass shade clear light: directed downwards, distributed all around	 Acrylglasschirm klar Licht: nach unten gerichtet, rundum abstrahlend acrylic glass shade clear light: directed downwards, distributed all around
	 Glasschirm klar, Reflektor konisch Licht: nach unten gerichtet, rundum weich gestreut glass shade clear, reflector conical light: directed downwards, diffused all around	 Acrylglasschirm klar, Reflektor konisch Licht: nach unten gerichtet, rundum weich gestreut acrylic glass shade clear, reflector conical light: directed downwards, diffused all around
	 Glasschirm klar, Reflektor zylindrisch Licht: nach unten gerichtet, rundum weich gestreut shade glass clear, reflector cylindrical light: directed downwards, diffused all around	 Acrylglasschirm klar, Reflektor zylindrisch Licht: nach unten gerichtet, rundum weich gestreut acrylic glass shade clear, reflector cylindrical light: directed downwards, diffused all around
	 Glasschirm opal Licht: nach unten gerichtet, rundum weich gestreut glass shade opal light: directed downwards, diffused all around	
	 Glasschirm neusilber Licht: nach unten gerichtet, rundum abstrahlend glass shade new silver light: directed downwards, distributed all around	
Sonstiges features	LED wechselbar, werkzeuglose Schirmmontage; 110 V-Varianten auf Anfrage; DALI-Varianten für den Einsatz in Notbeleuchtungsanlagen auf Anfrage LED exchangeable, shade tool-free mountable; 110 V versions on request; DALI versions for the use in emergency lighting systems on request	

CURLING ist ein modularer Artikel. Bitte jeweils Leuchteneinheit und Glasschirm zusammen bestellen.
CURLING is a modular article. Please order the lighting unit and glass shade together.

CURLING Suspension S/M – Zubehör / Accessories

Baldachinprofile Baldachine für 2 oder 3 CURLING Suspension an einem Deckenauslass finden Sie auf Seiten 198–199.
Canopy profiles Canopies for mounting zwei oder drei of CURLING Suspension on one ceiling outlet can be found on pages 198–199.

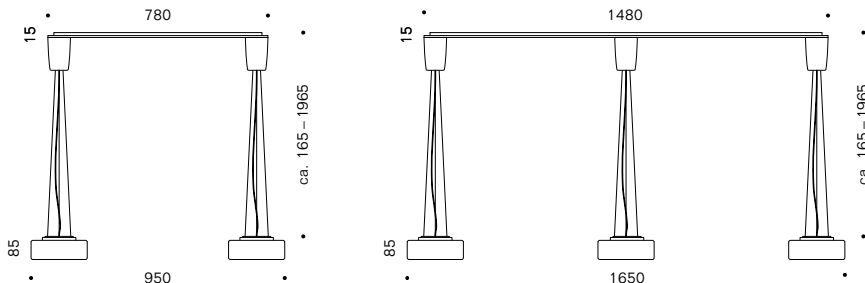











CURLING Suspension Rope M







CURLING Suspension S

Abbildung figure	Beschreibung description	Leuchtmittel lamp	Regelung control	Leistung power	CCT	Lumen lumen	Art.-Nr. art.-no.	€ netto CH excl. VAT	€ brutto CH incl. VAT
	Rope Leuchteinheit S Rope lighting unit S	LED	TRIAC	11 W	2700 K	1130 lm	LE015704	384,71 €	
					3000 K	1180 lm	LE015705	384,71 €	
					1800–3000 K D2W	870 lm	LE015706	416,76 €	
			DALI	11 W	2700 K	1130 lm	LE015735	416,76 €	
					3000 K	1180 lm	LE015736	416,76 €	
					1800–3000 K D2W	870 lm	LE015737	448,82 €	
	Tube Leuchteinheit S Tube lighting unit S	LED	TRIAC	11 W	2700 K	1130 lm	LE015707	343,49 €	
					3000 K	1180 lm	LE015708	343,49 €	
					1800–3000 K D2W	870 lm	LE015709	375,55 €	
			DALI	11 W	2700 K	1130 lm	LE015740	375,55 €	
					3000 K	1180 lm	LE015741	375,55 €	
					1800–3000 K D2W	870 lm	LE015742	407,61 €	
	Glas S klar glass S clear						CU014406	196,93 €	
	Glas S klar, Reflektor konisch glass S clear, reflector conical						CU014407	219,83 €	
	Glas S klar, Reflektor zylindrisch glass S clear, reflector cylindrical						CU014408	219,83 €	
	Glas S opal glass S opal						CU014405	187,77 €	
	Glas S neusilber glass S new silver						CU011201	279,37 €	
	Acrylglas S klar acrylic glass S clear						CU011203	82,44 €	
	Acrylglas S klar, Reflektor konisch acrylic glass S clear, reflector conical						CU011204	100,76 €	
	Acrylglas S klar, Reflektor zylindrisch acrylic glass S clear, reflector cylindrical						CU011205	100,76 €	

CURLING Suspension M

Abbildung figure	Beschreibung description	Leuchtmittel lamp	Regelung control	Leistung power	CCT	Lumen lumen	Art.-Nr. art.-no.	€ netto CH € brutto CH excl. VAT incl. VAT
	Rope Leuchteneinheit M Rope lighting unit M	LED	TRIAC 0–10 V	27 W	2700 K	2610 lm	LE015716	462,56 €
					3000 K	2750 lm	LE015717	462,56 €
					1800–3000 K D2W	2180 lm	LE015718	503,78 €
			DALI	27 W	2700 K	2610 lm	LE015719	494,62 €
					3000 K	2750 lm	LE015720	494,62 €
					1800–3000 K D2W	2180 lm	LE015721	535,84 €
	Tube Leuchteneinheit M Tube lighting unit M	LED	TRIAC 0–10 V	27 W	2700 K	2610 lm	LE015722	416,76 €
					3000 K	2750 lm	LE015723	416,76 €
					1800–3000 K D2W	2180 lm	LE015724	457,98 €
			DALI	27 W	2700 K	2610 lm	LE015725	448,82 €
					3000 K	2750 lm	LE015726	448,82 €
					1800–3000 K D2W	2180 lm	LE015727	490,04 €
	Glas M klar glass M clear						CU014402	247,31 €
	Glas M klar, Reflektor konisch glass M clear, reflector conical						CU014403	274,79 €
	Glas M klar, Reflektor zylindrisch glass M clear, reflector cylindrical						CU014404	274,79 €
	Glas M opal glass M opal						CU014401	233,57 €
	Glas M neusilber glass M new silver						CU011202	352,65 €
	Acrylglas M klar acrylic glass M clear						CU011206	109,92 €
	Acrylglas M klar, Reflektor konisch acrylic glass M clear, reflector conical						CU011207	137,39 €
	Acrylglas M klar, Reflektor zylindrisch acrylic glass M clear, reflector cylindrical						CU011208	137,39 €

CURLING Suspension L

Abbildung figure	Beschreibung description	Leuchtmittel lamp	Regelung control	Leistung power	CCT	Lumen lumen	Art.-Nr. art.-no.	€ netto CH € brutto CH excl. VAT incl. VAT
	Rope Leuchteneinheit L Rope lighting unit L	LED	TRIAC	34 W	2700 K	3360 lm	LE014486	503,78 €
					3000 K	3480 lm	LE014489	503,78 €
			DALI	34 W	2700 K	3360 lm	LE014484	545,00 €
					3000 K	3480 lm	LE014487	545,00 €
	Tube Leuchteneinheit L Tube lighting unit L	LED	TRIAC	34 W	2700 K	3360 lm	LE014492	453,40 €
					3000 K	3480 lm	LE014495	453,40 €
			DALI	34 W	2700 K	3360 lm	LE014490	494,62 €
					3000 K	3480 lm	LE014493	494,62 €
	Glas L klar glass clear						CU014475	338,91 €
	Glas L klar, Reflektor konisch glass clear, reflector conical						CU014476	375,55 €
	Glas L klar, Reflektor zylindrisch glass clear, reflector cylindrical						CU014477	375,55 €
	Glas L neusilber glass L new silver						CU014478	435,08 €

DRAFT Suspension

DRAFT macht aus der archetypischen Kugelleuchte ein Objekt von zeitgenössischer Prägnanz und perfekt ausbalancierter Lichtwirkung. Die transparente, mundgeblasene Glaskugel und der lichtdurchlässige, mattweiße Innenreflektor treten in einen spannenden Kontrast. Das LED-Leuchtmittel tief im Inneren des konischen Reflektors sorgt rundum für weich gestreutes Raumlicht und gerichtetes Licht nach unten. Eine Diffusorscheibe gewährleistet einen besonders weichen Lichtaustritt und gleichmäßig beleuchtete Flächen. DRAFT ist absolut blendfrei, verfügt über zwei verschiedene Lichtfarben und die Dim2warm-Funktion.

DRAFT turns the archetypal spherical luminaire into an object that boasts an unpretentious contemporary look and perfectly balanced light. The transparent, hand-blown glass ball and the translucent, matte white internal reflector make for a striking contrast. Set deep in the internal reflector, the LED illuminant delivers softly diffused all-round and downward directional light. A diffuser plate ensures particularly soft light and evenly illuminated spaces. DRAFT is absolutely glare-free, comes with two different light colors and the Dim2warm function.

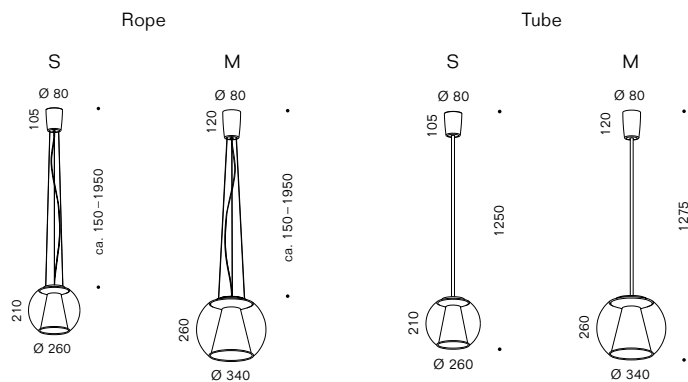

Leuchtmittel
lamp LED 11-27 W, CoB, CRI Ra>97 (R9>80), EEK/EEC F (2700 K, 3000 K), G (1800-3000 K D2W)

Leuchteneinheit
light unit **Aluminium hochglanzpoliert**
aluminum highly polished

Schirm
shade **mundgeblasenes Glas klar, Reflektor: Acrylglas opal**
hand-blown glass clear; reflector: acrylic glass opal





Ausführungen
versions **Glasschirm klar, Reflektor konisch opal; Licht: nach unten gerichtet, rundum weich gestreut**
glass shade clear, reflector conical; light: directed downwards, diffused all around





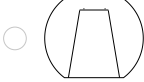
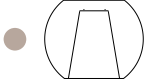

Sonstiges
features **LED wechselbar, werkzeuglose Schirmmontage; 110 V-Varianten auf Anfrage;**
DALI-Varianten für den Einsatz in Notbeleuchtungsanlagen auf Anfrage
LED exchangeable, shade tool-free mountable; 110 V versions on request;
DALI Versions for the use in emergency lighting systems on request

DRAFT ist ein modularer Artikel. Bitte jeweils Leuchteneinheit und Glasschirm zusammen bestellen.
DRAFT is a modular article. Please order the lighting unit and glass shade together.

DRAFT Suspension S

Abbildung figure	Beschreibung description	Leuchtmittel lamp	Regelung control	Leistung power	CCT	Lumen lumen	Art.-Nr. art.-no.	€ netto CH € excl. VAT	brutto CH incl. VAT
	Rope Leuchteinheit S Rope lighting unit S	LED	TRIAC	11 W	2700 K	1130 lm	LE015704	384,71 €	
					3000 K	1180 lm	LE015705	384,71 €	
					1800–3000 K D2W	870 lm	LE015706	416,76 €	
			DALI	11 W	2700 K	1130 lm	LE015735	416,76 €	
					3000 K	1180 lm	LE015736	416,76 €	
					1800–3000 K D2W	870 lm	LE015737	448,82 €	
	Tube Leuchteinheit S Tube lighting unit S	LED	TRIAC	11 W	2700 K	1130 lm	LE015707	343,49 €	
					3000 K	1180 lm	LE015708	343,49 €	
					1800–3000 K D2W	870 lm	LE015709	375,55 €	
			DALI	11 W	2700 K	1130 lm	LE015740	375,55 €	
					3000 K	1180 lm	LE015741	375,55 €	
					1800–3000 K D2W	870 lm	LE015742	407,61 €	
	Glas S klar mit Reflektor glass S clear with reflector						DR015728	270,21 €	
	Glas S braun mit Reflektor glass S brown with reflector						DR015729	311,43 €	
	Glas S blau mit Reflektor glass S blue with reflector						DR015730	311,43 €	

DRAFT Suspension M

Abbildung figure	Beschreibung description	Leuchtmittel lamp	Regelung control	Leistung power	CCT	Lumen lumen	Art.-Nr. art.-no.	€ netto CH € excl. VAT	brutto CH incl. VAT
	Rope Leuchteinheit M Rope lighting unit M	LED	TRIAC	27 W	2700 K	2610 lm	LE015716	462,56 €	
					3000 K	2750 lm	LE015717	462,56 €	
					1800–3000 K D2W	2180 lm	LE015718	503,78 €	
			DALI	27 W	2700 K	2610 lm	LE015719	494,62 €	
					3000 K	2750 lm	LE015720	494,62 €	
					1800–3000 K D2W	2180 lm	LE015721	535,84 €	
	Tube Leuchteinheit M Tube lighting unit M	LED	TRIAC	27 W	2700 K	2610 lm	LE015722	416,76 €	
					3000 K	2750 lm	LE015723	416,76 €	
					1800–3000 K D2W	2180 lm	LE015724	457,98 €	
			DALI	27 W	2700 K	2610 lm	LE015725	448,82 €	
					3000 K	2750 lm	LE015726	448,82 €	
					1800–3000 K D2W	2180 lm	LE015727	490,04 €	
	Glas M klar mit Reflektor glass M clear with reflector						DR015731	357,23 €	
	Glas M braun mit Reflektor glass M brown with reflector						DR015732	407,61 €	
	Glas M blau mit Reflektor glass M blue with reflector						DR015733	407,61 €	

DRAFT Suspension S / M – Zubehör / Accessories

Baldachinprofile Baldachine für die Montage von zwei oder drei DRAFT Suspension an nur einem Deckenauslass finden Sie auf Seiten 198–199.
Canopy profiles Canopies for mounting 2 or drei DRUM Suspension on only one ceiling outlet can be found on pages 198–199.

DRUM Suspension

DRUM Suspension holt die schlichte Zylinderform von der Decke in den Raum und spielt mit dem geometrisch angepassten Volumen des opalen Innenreflektors. **DRUM Suspension Tube** passt mit ihrem rundum mild gestreuten Licht und gerichtetem Licht nach unten besonders gut in Flure oder Treppenhäuser, **DRUM Suspension Rope** mit ihrer feinen Stahlseilabhängung über Tische und Theken. **DRUM** ist absolut blendfrei, verfügt über zwei verschiedene Lichtfarben und die Dim2warm-Funktion.

DRUM Suspension brings the straightforward cylindrical shape down into the room and playfully deploys the geometrically adjusted volume of the opale internal reflector. DRUM Suspension Tube which diffuses light so mildly right round, directing light carefully downward, is ideal for corridors or stairwells, DRUM Suspension Rope with its fine steel cable suspension fits well over tables or bar tops. DRUM is absolutely glare-free, comes with two different light colors and the Dim2warm function.

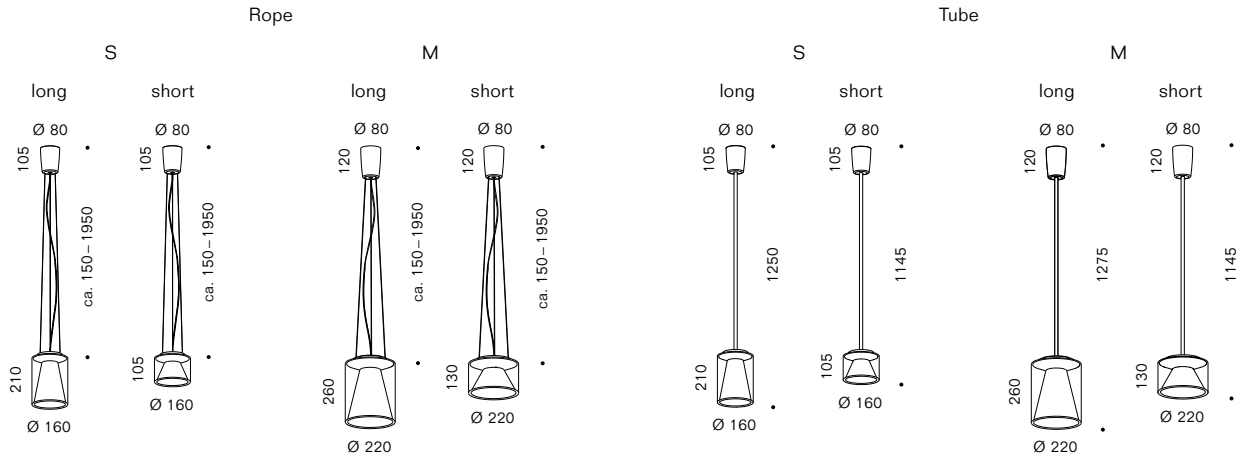

Licht
light **nach unten gerichtet, rundum weich gestreut**
directed downwards, diffused all around

Leuchtmittel
lamp LED 11-27 W, CoB, CRI Ra>97 (R9>80), EEK/EEC F (2700 K, 3000 K), G (1800-3000 K D2W)

Leuchteneinheit
light unit **Aluminium hochglanzpoliert**
aluminum highly polished

Glasschirm
glass shade **mundgeblasenes Glas klar, Reflektor: Acrylglas opal**
hand-blown glass clear; reflector: acrylic glass opal

Abhängung
suspension **Edelstahlseil oder Stahlrohr verchromt**
stainless steel rope or chromed steel tube



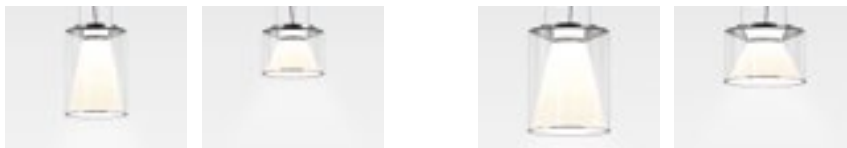

Ausführungen
versions







Sonstiges
features **LED wechselbar, werkzeuglose Schirmmontage; 110 V-Varianten auf Anfrage; DALI-Varianten für den Einsatz in Notbeleuchtungsanlagen auf Anfrage**
LED exchangeable, shade tool-free mountable; 110 V versions on request; DALI versions for the use in emergency lighting systems on request

DRUM ist ein modularer Artikel. Bitte jeweils Leuchteneinheit und Glasschirm zusammen bestellen.
DRUM is a modular article. Please order the lighting unit and glass shade together.

DRUM Suspension S

Abbildung figure	Beschreibung description	Leuchtmittel lamp	Regelung control	Leistung power	CCT	Lumen lumen	Art.-Nr. art.-no.	€ netto CH € brutto CH excl. VAT incl. VAT
	Rope Leuchteneinheit S Rope lighting unit S	LED	TRIAC	11 W	2700 K	1130 lm	LE015704	384,71 €
					3000 K	1180 lm	LE015705	384,71 €
					1800–3000 K D2W	870 lm	LE015706	416,76 €
			DALI	11 W	2700 K	1130 lm	LE015735	416,76 €
					3000 K	1180 lm	LE015736	416,76 €
					1800–3000 K D2W	870 lm	LE015737	448,82 €
	Tube Leuchteneinheit S Tube lighting unit S	LED	TRIAC	11 W	2700 K	1130 lm	LE015707	343,49 €
					3000 K	1180 lm	LE015708	343,49 €
					1800–3000 K D2W	870 lm	LE015709	375,55 €
			DALI	11 W	2700 K	1130 lm	LE015740	375,55 €
					3000 K	1180 lm	LE015741	375,55 €
					1800–3000 K D2W	870 lm	LE015742	407,61 €
	Glas S long mit Reflektor glass S long with reflector						DU015801	206,09 €
	Glas S short mit Reflektor glass S short with reflector						DU015802	155,71 €

DRUM Suspension M

Abbildung figure	Beschreibung description	Leuchtmittel lamp	Regelung control	Leistung power	CCT	Lumen lumen	Art.-Nr. art.-no.	€ netto CH € brutto CH excl. VAT incl. VAT
	Rope Leuchteneinheit M Rope lighting unit M	LED	TRIAC	27 W	2700 K	2610 lm	LE015716	462,56 €
					3000 K	2750 lm	LE015717	462,56 €
					1800–3000 K D2W	2180 lm	LE015718	503,78 €
			DALI	27 W	2700 K	2610 lm	LE015719	494,62 €
					3000 K	2750 lm	LE015720	494,62 €
					1800–3000 K D2W	2180 lm	LE015721	535,84 €
	Tube Leuchteneinheit M Tube lighting unit M	LED	TRIAC	27 W	2700 K	2610 lm	LE015722	416,76 €
					3000 K	2750 lm	LE015723	416,76 €
					1800–3000 K D2W	2180 lm	LE015724	457,98 €
			DALI	27 W	2700 K	2610 lm	LE015725	448,82 €
					3000 K	2750 lm	LE015726	448,82 €
					1800–3000 K D2W	2180 lm	LE015727	490,04 €
	Glas M long mit Reflektor glass M long with reflector						DU015803	242,73 €
	Glas M short mit Reflektor glass M short with reflector						DU015804	187,77 €

DRUM Suspension S/M – Zubehör / Accessories

Baldachinprofile Baldachine für die Montage von zwei oder drei DRUM Suspension an nur einem Deckenauslass finden Sie auf Seiten 198–199.
Canopy profiles Canopies for mounting two or three DRUM Suspension on only one ceiling outlet can be found on pages 198–199.

ONE EIGHTY Suspension

Als Pendelversion besonders geeignet auch zur Reihung mehrerer Leuchten, wirkt ONE EIGHTY Suspension unaufdringlich elegant. Mit zwei Schirmgrößen und zahlreichen Varianten, wahlweise mit einstellbarer Festlänge oder bequemer Höhenverstellung (Adjustable) kann jede Situation perfekt ausgeleuchtet werden.

Also particularly suitable for lining up rows of lamps, as a suspended version ONE EIGHTY Suspension makes an unobtrusive, elegant impression. With two shade sizes and numerous versions, available with optional set length or easy height adjustment, every situation can be lit perfectly.

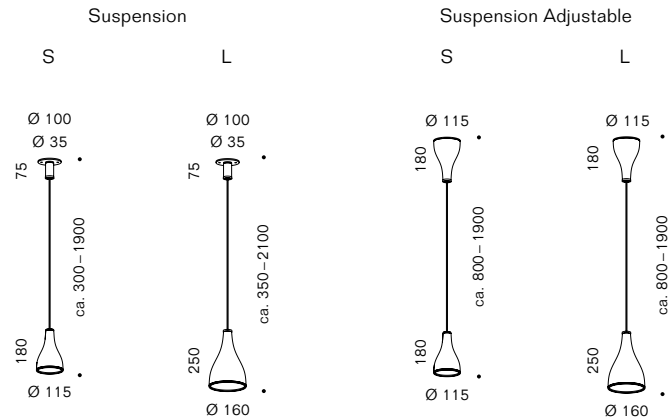



Licht
light **nach vorne gerichtet, seitlich abgeschirmt**
directed forward, shielded to the sides

Leuchtmittel
lamp **S: GU10, L: E27 (Lieferung ohne Leuchtmittel)**
S: GU10, L: E27 (delivery without bulb)



Baldachin & Schirm
canopy & shade **Aluminium gebürstet, weiß oder schwarz lackiert; Zierringe: Stahl vernickelt**
brushed aluminium with protective coating, coated white or black; decorative rings: steel nickel plated





ONE EIGHTY Suspension S

Abbildung figure	Beschreibung description	Fassung socket	Regelung control	Leistung power	Art.-Nr. art.-no.	€ netto CH excl. VAT	€ brutto CH incl. VAT
	gebürstet brushed	GU10	TRIAC	max. 60	OE1001	366,39 €	
	schwarz black	GU10	TRIAC	max. 60	OE1021	366,39 €	
	weiß white	GU10	TRIAC	max. 60	OE1003	366,39 €	



ONE EIGHTY Suspension Adjustable S

Abbildung figure	Beschreibung description	Fassung socket	Regelung control	Leistung power	Art.-Nr. art.-no.	€ netto CH excl. VAT	€ brutto CH incl. VAT
	gebürstet brushed	GU10	TRIAC	max. 60	OE1002	457,98 €	
	schwarz black	GU10	TRIAC	max. 60	OE1022	457,98 €	
	weiß white	GU10	TRIAC	max. 60	OE1004	457,98 €	

ONE EIGHTY Suspension L

Abbildung figure	Beschreibung description	Fassung socket	Regelung control	Leistung power	Art.-Nr. art.-no.	€ netto CH excl. VAT	€ brutto CH incl. VAT
	gebürstet brushed	E27	TRIAC	max. 100	OE1005	412,18 €	
	schwarz black	E27	TRIAC	max. 100	OE1023	412,18 €	
	weiß white	E27	TRIAC	max. 100	OE1007	412,18 €	

ONE EIGHTY Suspension Adjustable L

Abbildung figure	Beschreibung description	Fassung socket	Regelung control	Leistung power	Art.-Nr. art.-no.	€ netto CH excl. VAT	€ brutto CH incl. VAT
	gebürstet brushed	E27	TRIAC	max. 100	OE1006	522,10 €	
	schwarz black	E27	TRIAC	max. 100	OE1024	522,10 €	
	weiß white	E27	TRIAC	max. 100	OE1008	522,10 €	

POPPY Suspension

Werden die „Mohnblüten“ dieser Familie durch Einschalten geweckt, öffnen sich ihre Schirme ganz allmählich: die feinen Blätter sind aus Bimetall und dehnen sich durch Erwärmung aus. Alle Varianten können nach Belieben umgestaltet werden. Der flexible, textilmantelte Schlauch lässt sich immer neu biegen – zur Änderung der Lichtrichtung, oder einfach weil Ihnen danach ist. Die mundgeblasenen Glaskapseln sind erhältlich in den Farben keramik, rubinrot oder violett.

When the “poppy flowers” in this family are woken by the lamp being switched on, their shades open very gradually: the delicate leaves are bi-metallic and expand when heated. All the versions can be reshaped as desired. The flexible, textile-coated stem can be bent at will, to change the direction of the light, or because you just feel like it. The hand-blown glass capsules are available in ceramic, ruby red or violet.

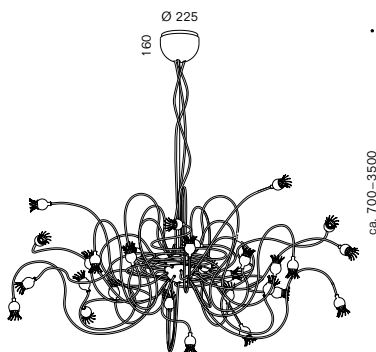

Licht
light **nach vorne gerichtet, rundum dekorativ**
directed forward, decorative all around

Leuchtmittel
lamp **30 x G4 20 W, 12 V, EEK/EEC G**

Material
material **30 Arme, flexibel: Aluminium, textilmantelt beige oder schwarz, Länge 150 cm; Glasschirme: mundgeblasenes Glas in keramik, rubinrot oder violett; Lamellen: Bimetall. Baldachin: Edelstahl gebürstet**
30 arms, flexible: textile coated aluminium tube in beige or black; length 150 cm
glass shade: hand-blown glass in ceramic, ruby red or violet; lamellae: bimetal; canopy: stainless steel, polished

Sonstiges
features **Leuchtmittel in Lieferung enthalten; Reflektor-Lamellen öffnen sich nach ca. 2 Minuten Betriebszeit**
lamps included in delivery; lamellae open within approx. 2 minutes after switching on luminaire

POPPY Suspension

Abbildung figure	Beschreibung description	Fassung socket	Regelung control	Leistung power	Art.-Nr. art.-no.	€ netto CH excl. VAT	€ brutto CH incl. VAT
	30 Arme schwarz, Schirme keramik 30 arms black, shades ceramic	30 x G4	ON/OFF	max. 600 W	PO1004	4.763,03 €	
	30 Arme schwarz, Schirme rubinrot 30 arms black, shades red	30 x G4	ON/OFF	max. 600 W	PO1005	4.763,03 €	
	30 Arme schwarz, Schirme violett 30 arms black, shades violet	30 x G4	ON/OFF	max. 600 W	PO1006	4.763,03 €	
	30 Arme beige, Schirme keramik 30 arms beige shades ceramic	30 x G4	ON/OFF	max. 600 W	PO1019	4.763,03 €	
	30 Arme beige, Schirme rubinrot 30 arms beige shades red	30 x G4	ON/OFF	max. 600 W	PO1020	4.763,03 €	
	30 Arme beige, Schirme violett 30 arms beige shades violet	30 x G4	ON/OFF	max. 600 W	PO1021	4.763,03 €	

PROPELLER Suspension

Dieser wunderbar zarte Entwurf ist ein überaus effizienter, geräuschloser Ventilator und zentrale Deckenbeleuchtung zugleich. Über ein filigranes Federdrahtgestell wird einfach ein (waschbares) elastisches Gewebe gezogen. Von innen beleuchtet, entsteht eine ebenso reizvolle wie nützliche animierte Skulptur. Und mit einer Funk-Fernbedienung regeln Sie die Drehzahl und die Drehrichtung bequem von Ihrem Lieblingsplatz aus.

This wonderfully delicate design is an extremely efficient, silent fan and main ceiling lighting at one and the same time. A (washable) elastic fabric is just pulled over a filigree spring wire frame. Illuminated from inside, an animated sculpture emerges that is as charming as it is useful. And with a remote control you can easily regulate the number of revolutions and the direction of rotation from your favorite spot.

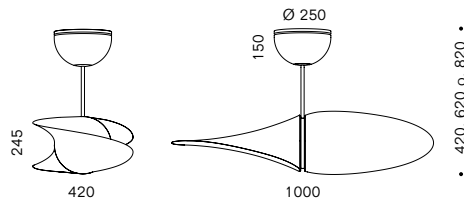

Licht light	gestreut durch den Stoffüberzug diffused through fabric cover
Leuchtmittel lamp	E27, nicht dimmbar, max. 105 W; Lieferung ohne Leuchtmittel E27, not dimmable, max. 105 W; delivery without bulb
Material material	Baldachin und Rohr: Aluminium gebürstet; Flügel: Stoffüberzug weiß aus 80% Polyamid und 20% Elasthan gespannt über Federstahl canopy and tube: aluminium brushed; wings: fabric cover white made of 80% polyamide and 20% elastane stretched over spring wire steel
Sonstiges features	Fernbedienung; Licht: An/Aus/nicht dimmbar, kompatibel mit LED-Lampen und steuerbaren LED-Lampen; Motor: Ein/Aus/Vor- bzw. Rückwärtslauf; variable Rotationsgeschwindigkeit (6-stufig mit Memory-Funktion, 25 U/Min (4 W) bis 140 U/Min.(16 W) Remote control; light: on/off/ not dimmable, compatible with LED lamps and controllable LED lamps; Motor: on/off/forward or reverse; variable rotational speed (6-stage speed control with memory function, from approx. 25 RPM (4 W) up to 140 RPM (16 W)

PROPELLER Suspension

Abbildung figure	Beschreibung description	Fassung socket	Regelung control	Leistung power	Art.-Nr. art.-no.	€ netto CH excl. VAT	€ brutto CH incl. VAT
	Länge 420 mm length 420 mm	E27	ON/OFF	max. 105 W	PR2101	1.172,44 €	
	Länge 620 mm length 620 mm	E27	ON/OFF	max. 105 W	PR2102	1.172,44 €	
	Länge 820 mm length 820 mm	E27	ON/OFF	max. 105 W	PR2103	1.172,44 €	

REEF Suspension

Die unverwechselbaren Leuchtschirme dieser Familie bestehen aus innovativer Schaumkeramik, deren Struktur stark an Korallen erinnert. Dabei sind sie durabel, spülmaschinentauglich und verteilen das Streulicht perfekt in einem sanften Bone China-Farbtönen. Die zylindrischen Körper sind einseitig offen – so strahlen die Leuchten dieser Familie kräftig und brillant, aber völlig blendfrei.

The unmistakable lamp shades in this family are made of innovative foam ceramic, whose texture is highly reminiscent of corals. That said they are durable, dishwasher-proof and distribute the scattered light perfectly in a gentle bone china hue. The cylindrical objects are open on one side, such that the lamps in this family shine powerfully and brightly, though without any glare at all.

DESIGN PLUS



Internationaler Designpreis Baden-Württemberg 2003



reddot design award winner 2004

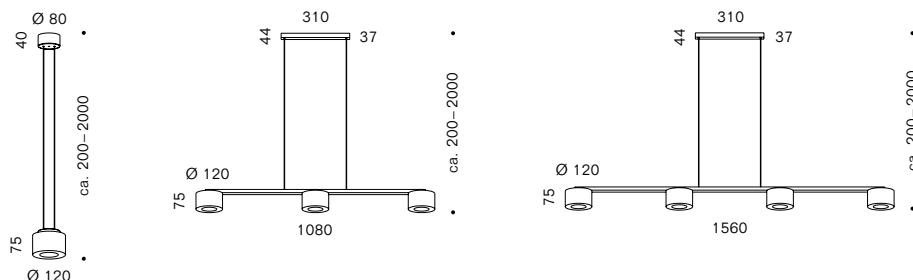

Licht
light **nach unten gerichtet, rundum diffus**
directed downwards, diffuse all around

Leuchtmittel
lamp **LED 1 x, 3 x, 4 x 8 W, CoB, CRI Ra>90, EEK/EEC F**
1 x, 3 x, 4 x G9 20 W, EEK/EEC G

Gehäuse
Housing **Aluminium poliert oder gebürstet; Schirm: Keramikschaum weiß**
aluminium polished or brushed; shade: ceramic foam white

Sonstiges
features **LED austauschbar; Schirm werkzeuglos abnehmbar und spülmaschinenfest**
LED exchangeable; shade tool-free removable and dishwasher safe

REEF Suspension 1

Abbildung figure	Beschreibung description	Leuchtmittel lamp	Regelung control	Leistung power	CCT	Lumen lumen	Art.-Nr. art.-no.	€ netto CH excl. VAT	€ brutto CH incl. VAT
●	gebürstet brushed	LED	TRIAC	8 W	2700 K	660 lm	RF2018	407,61 €	
●	poliert polished	LED	TRIAC	8 W	2700 K	660 lm	RF2017	407,61 €	

REEF Suspension 3

Abbildung figure	Beschreibung description	Leuchtmittel lamp	Regelung control	Leistung power	CCT	Lumen lumen	Art.-Nr. art.-no.	€ netto CH excl. VAT	€ brutto CH incl. VAT
●	gebürstet brushed	LED	TRIAC	26 W	2700 K	2820 lm	RF2021	1.236,55 €	
		3 x G9	TRIAC	max. 180 W	2700 K	2940 lm	RF1006	970,92 €	

REEF Suspension 4

Abbildung figure	Beschreibung description	Leuchtmittel lamp	Regelung control	Leistung power	CCT	Lumen lumen	Art.-Nr. art.-no.	€ netto CH excl. VAT	€ brutto CH incl. VAT
●	gebürstet brushed	LED	TRIAC	38 W	2700 K	3760 lm	RF2031	1.419,75 €	
		4 x G9	TRIAC	max. 240 W	2700 K	3020 lm	RF1008	1.080,84 €	

REEF Suspension 1 – Zubehör / Accessories

Baldachinprofile **Baldachine für die Montage von zwei oder drei REEF Suspension 1 an nur einem Deckenauslass finden Sie auf Seiten 198–199.**
Canopy profiles Canopies for mounting two or three REEF Suspension 1 on only one ceiling outlet can be found on pages 198–199.

TWIN

Der Aufbau dieser eleganten Pendelleuchte ist einfach und transparent, ohne nüchtern zu wirken und verweist auf ihr Funktionsprinzip. Um den Abstand der Zwillingsschirme zu verstellen, werden die Leuchtenarme einfach und leichtgängig auseinander gezogen und so den jeweiligen Bedürfnissen angepasst. Unabhängig vom Winkel der Arme bleiben die Schirme dabei stets waagrecht. Ist TWIN ganz ausgezogen, eröffnet sich zwischen den Schirmen ein Raum, der wunderbar genutzt werden kann – zum Beispiel für größere Vasen und Blumengestecke auf dem Tisch.

DESIGN PLUS



The structure of this elegant suspended lamp is straightforward and transparent, without seeming sober, and highlights its function. To alter the distance between the two shades, the arms of the lamp are simply pulled apart and thus adapted to the relevant needs. Regardless of the angle of the arms the shades stay horizontal at all times. If TWIN is fully expanded a space opens up between the two shades that can be put to optimum use, for example for large vases and bouquets on the table top.

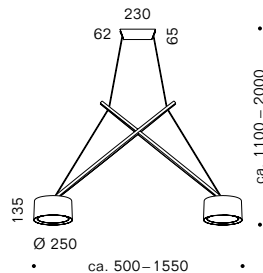

Licht light	direkt nach unten, rundum diffus directed downwards, diffuse all around
Leuchtmittel lamp	LED 2 x 11,5 W, CoB, CRI Ra>97 (R9>80), EEK/EEC F (2700 K), E (3000 K) 2 x 60 W, 2 x G9, EEK/EEC G
Material material	Leuchtenarme und Baldachin: Aluminium glanzverchromt oder schwarz seidenmatt lackiert; Schirme: Acrylglas opal weiß oder mundgeblasenes Glas opal weiß; Kabel: textillummantelt, schwarz arms and canopy: Aluminium bright chrome-plated or black lacquered; shades: Acrylic glass opal white or hand-blown translucent genuine glass; cable: textile coated black
Sonstiges features	LED wechselbar; Schirmabstand über Scherengitterprinzip stufenlos verstellbar; geeignet bis Deckenhöhe ca 3,3 m (weitere Kabellängen auf Anfrage) und Tischlängen bis 3,3 m LED exchangeable; shade spacing can be set as desired due to its snake fence structure; suitable for ceiling heights up to 3.3 m (other lengths on request) and tables up to 3.3 m long

TWIN Suspension

Abbildung figure	Beschreibung description	Leuchtmittel lamp	Regelung control	Leistung power	CCT	Lumen lumen	Art.-Nr. art.-no.	€ netto CH excl. VAT	€ brutto CH incl. VAT
●	schwarz, Acrylglas opal black, acrylic glass opal	LED	TRIAC	23 W	2700 K	2240 lm	TW1103	1.318,99 €	
					3000 K	2360 lm	TW1107	1.318,99 €	
		2 x G9	TRIAC	max. 120 W	2800 K	1960 lm	TW1003	980,08 €	
●	schwarz, Glas opal black, glass opal	LED	TRIAC	23 W	2700 K	2240 lm	TW1303	1.547,98 €	
					3000 K	2360 lm	TW1307	1.547,98 €	
		2 x G9	TRIAC	max. 120 W	2800 K	1960 lm	TW1203	1.181,60 €	
●	glanzverchromt, Acrylglas opal chrome-plated, acrylic glass opal	LED	TRIAC	23 W	2700 K	2240 lm	TW1101	1.419,75 €	
					3000 K	2360 lm	TW1105	1.419,75 €	
		2 x G9	TRIAC	max. 120 W	2800 K	1960 lm	TW1001	1.080,84 €	
●	glanzverchromt, Glas opal chrome-plated, glass opal	LED	TRIAC	23 W	2700 K	2240 lm	TW1301	1.639,58 €	
					3000 K	2360 lm	TW1305	1.639,58 €	
		2 x G9	TRIAC	max. 120 W	2800 K	1960 lm	TW1201	1.273,19 €	

ZOOM, ZOOM XL

Wenn man ein flexibles Scherengitter zum Kreis schließt, kann dieser seinen Durchmesser ändern – ein Effekt, den man am ehesten mit einem Kamera-ZOOM beschreiben kann. In Größe und Gestalt durchaus ein moderner Kronleuchter, wirkt ZOOM besonders imposant in den Versionen mit zwei oder drei Leuchtringen, die individuell gestuft werden können. Und für den ganz großen Auftritt gibt es ZOOM XL mit einem maximalen Durchmesser von 2.60 Metern.

If you form a circle with a flexible concertina mesh, the latter's diameter can change, an effect that can best be described with a camera zoom. In terms of size and shape by all means a modern-day chandelier, ZOOM is particularly impressive in the versions with two or three rings of lights, which can be individually layered. And for that big occasion there is ZOOM XL, which has a maximum diameter of 2.60 meters.

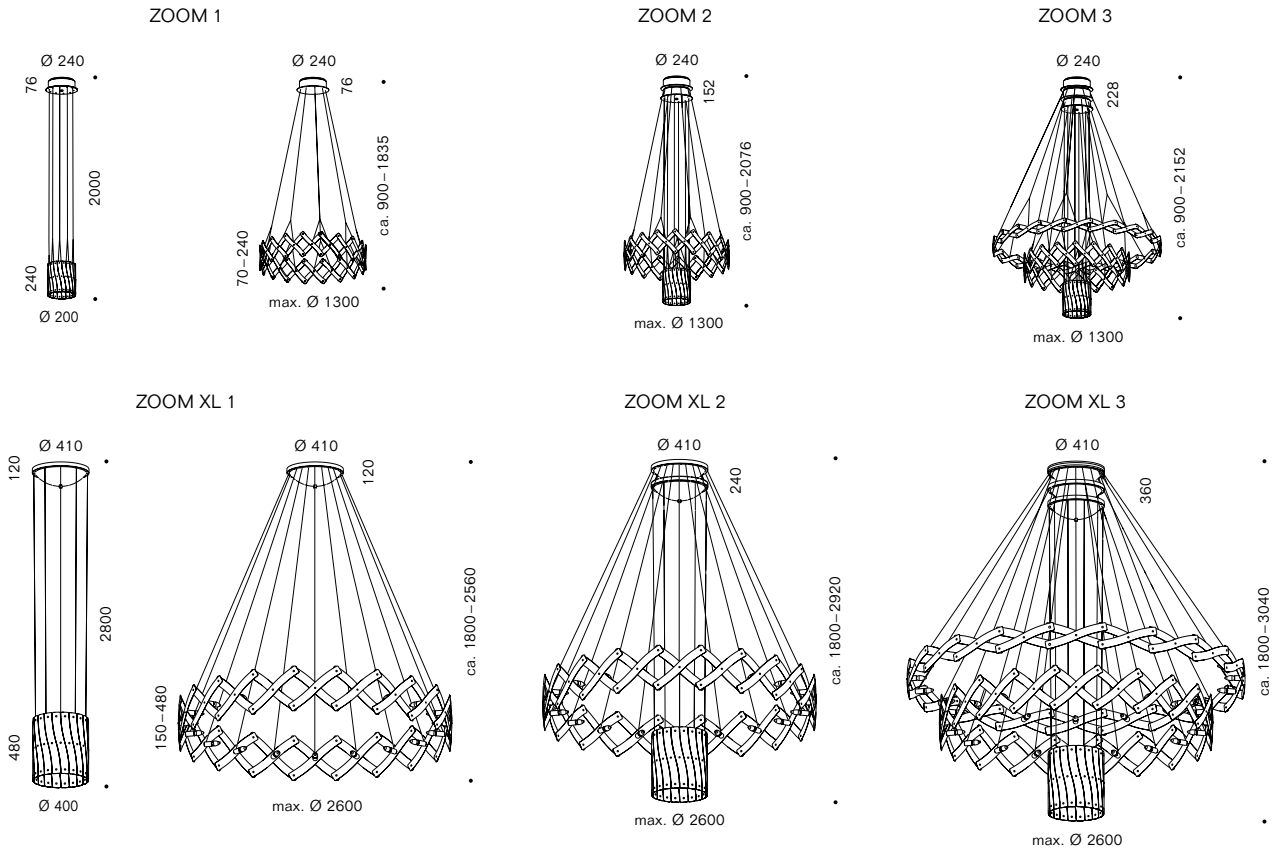

Licht light	frei abstrahlend, diffus durch Lamellen free radiating, diffused through lamellae		
Leuchtmittel lamp	ZOOM 1 LED 20 x 1,5 W, CRI Ra>90, EEK/EEC F G4 20 x 10 W, EEK/EEC G ZOOM XL 1 20 x E14 ohne Leuchtmittel/without bulbs	ZOOM 2 LED 40 x 1,5 W, CRI Ra>90, EEK/EEC F G4 40 x 10 W, EEK/EEC G ZOOM XL 2 40 x E14 ohne Leuchtmittel/without bulbs	ZOOM 3 LED 60 x 1,5 W CRI Ra>90, EEK/EEC F G4 60 x 10 W, EEK/EEC G ZOOM XL 3 60 x E14 ohne Leuchtmittel/without bulbs
Gehäuse Housing	Baldachin: Edelstahl gebürstet; Lamellen Edelstahl gebürstet, transluzente weiße Folie canopy: brushed stainless steel; lamellae: brushed stainless steel, translucent foil		
Sonstiges features	Durchmesser über Scherengitterprinzip stufenlos verstellbar. Für maximalen Durchmesser beträgt die Mindestabhängung 900 mm, bei geschlossener Leuchte. Die Leuchte steigt durch völliges Öffnen um 350 mm. Optional erhältlich: ZOOM Kristallglas Anhänger. Funkelnde Kristallketten aus Bleikristallglas die einfach in die unteren Scherengitterdrehpunkte eingehängt werden. LED und Halogen Leuchtmittel austauschbar. Diameter continuously adjustable. For maximum diameter minimum suspension is 900 mm when lamp closed. Lamp will rise 350 mm when completely opened. Optional available: ZOOM crystal glass pendants. Sparkling crystal chains of lead crystal glass which are hooked into the lower scissor lattice pivot points. LED and halogen bulbs exchangeable.		

ZOOM 1

Abbildung figure	Beschreibung description	Leuchtmittel lamp	Regelung control	Leistung power	CCT	Lumen lumen	Art.-Nr. art.-no.	€ netto CH excl. VAT	€ brutto CH incl. VAT
●	gebürstet brushed	LED	TRIAC	35 W	2700 K	2700 lm	ZO3001	1.364,79 €	
			DALI	35 W	2700 K	2580 lm	ZO3011	1.456,39 €	
		20 × G4	TRIAC	max. 200 W	2700 K	2600 lm	ZO1001	961,76 €	

ZOOM 2

Abbildung figure	Beschreibung description	Leuchtmittel lamp	Regelung control	Leistung power	CCT	Lumen lumen	Art.-Nr. art.-no.	€ netto CH excl. VAT	€ brutto CH incl. VAT
●	gebürstet brushed	LED	TRIAC	70 W	2700 K	5400 lm	ZO3002	2.656,30 €	
			DALI	70 W	2700 K	5160 lm	ZO3012	2.839,50 €	
		40 × G4	TRIAC	max. 400 W	2700 K	5200 lm	ZO1003	1.831,93 €	

ZOOM 3

Abbildung figure	Beschreibung description	Leuchtmittel lamp	Regelung control	Leistung power	CCT	Lumen lumen	Art.-Nr. art.-no.	€ netto CH excl. VAT	€ brutto CH incl. VAT
●	gebürstet brushed	LED	TRIAC	105 W	2700 K	8100 lm	ZO3003	3.938,66 €	
			DALI	105 W	2700 K	7740 lm	ZO3013	4.213,45 €	
		60 × G4	TRIAC	max. 600 W	2700 K	7800 lm	ZO1006	2.656,30 €	

ZOOM XL 1

Abbildung figure	Beschreibung description	Fassung socket	Regelung control	Leistung power	Art.-Nr. art.-no.	€ netto CH excl. VAT	€ brutto CH incl. VAT
●	gebürstet brushed	20 × E14	TRIAC	max. 560 W	ZO1002	2.839,50 €	

ZOOM XL 2

Abbildung figure	Beschreibung description	Fassung socket	Regelung control	Leistung power	Art.-Nr. art.-no.	€ netto CH excl. VAT	€ brutto CH incl. VAT
●	gebürstet brushed	40 × E14	TRIAC	max. 1120 W	ZO1004	5.587,39 €	

ZOOM XL 3

Abbildung figure	Beschreibung description	Fassung socket	Regelung control	Leistung power	Art.-Nr. art.-no.	€ netto CH excl. VAT	€ brutto CH incl. VAT
●	gebürstet brushed	60 × E14	TRIAC	max. 1680 W	ZO1005	8.335,29 €	







CAVITY Suspension • aluminium gloss finish

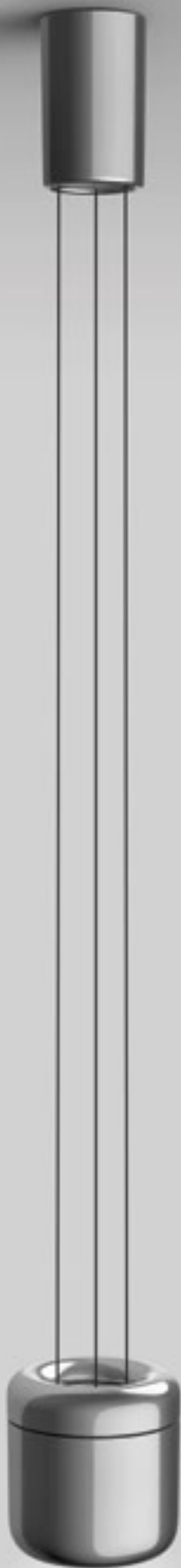

CAVITY Suspension • white



SUSPENSION

CAVITY Suspension • black



CAVITY Suspension • bronze finish









CURLING Suspension Tube M • glass new silver



CURLING Suspension Rope M • glass clear



SUSPENSION

**CURLING Suspension Rope M • glass clear
reflector: conical**



**CURLING Suspension Rope M • glass clear
reflector: cylindrical**





clear



blue



brown







Rope S · long



Rope S · short



Rope M · long



Rope M · short







white



90

silver



black





SUSPENSION







TWIN • chrome-plated



SUSPENSION









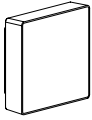

APP
S. 102



CAVITY
S. 105



CLUB
S. 106



CRIB
S. 107

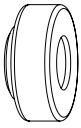

CURLING
S. 108

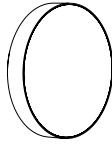

LID
S. 110

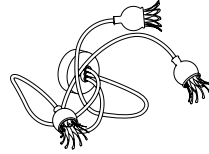

POPPY
S. 112



REEF
S. 115



REFLEX²
S. 116

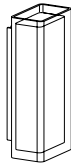

ROD
S. 117



SML
S. 118



SML²
S. 120

APP Wall

Kluges Licht, kreative Vielfalt! Ein formal schlichter LED-Leuchtquader zeigt, was in ihm steckt. Mit seiner doppellagigen Frontfläche eröffnet er größten Gestaltungsspielraum. Allein die Bandbreite der verfügbaren Standard-Fronten reicht von unterschiedlichen Strukturoberflächen über sanft mattierte Farben bis hin zu Spiegelflächen und solchen mit optischen Effekten. Wer ein Statement setzen oder eine Botschaft transportieren möchte, lässt APP mit individuellen Prints personalisieren. Hinweise, Zimmernummern, Firmenfarben... Sie haben die Wahl.



Intelligent light, creative diversity! A formally reduced LED cube shows the power within. With its double-layered front surface APP opens up immense creative scope. Even the range of standard fronts available allows numerous options from different textured structures to restrained satin colors to mirrored surfaces and those with visual effects. Those who want to make a statement or transport a message can have App personalized with individual prints. Notes, room numbers, corporate colors... it's up to you!

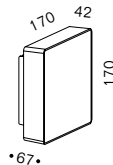

Licht
light **nach oben und unten streuend, seitlich diffus**
up- and downwards dispersed, diffuse to the sides

Leuchtmittel
lamp LED 16–22 W, CRI Ra>90, EEK/EEC E











Leuchteneinheit
light unit **Kühlkörper: Aluminium; Schirm: Polycarbonat klar**
heatsink: aluminium; shade: polycarbonate clear

Front
front **Plexiglas®, Echtglas**
Plexiglas®, genuine glass



Sonstiges
features **LED austauschbar; Fronten als Sonderausführungen in allen gängigen Plexiglas 3 mm Platten und als Foliendruck möglich; IP44 und 110 V-Varianten auf Anfrage; DALI-Varianten sind geeignet für den Einsatz in Notbeleuchtungsanlagen**
LED exchangeable; Fronts available in special versions in all common Plexiglas 3 mm panels and with foil printing; IP44 and 110 V-version on request; DALI versions are suitable for the use in emergency lighting systems

APP Wall

Abbildung figure	Beschreibung description	Leuchtmittel lamp	Regelung control	Leistung power	CCT	Lumen lumen	Art.-Nr. art.-no.	€ netto CH excl. VAT	€ brutto CH incl. VAT
	Leuchteneinheit APP lighting unit APP	LED	TRIAC	16 W	2700 K	1880 lm	AP1001	306,85 €	
					3000 K	1880 lm	AP1002	306,85 €	
			DALI	22 W	2700 K	2690 lm	AP1005	348,07 €	
					3000 K	2690 lm	AP1006	348,07 €	
	Front Rippe front ribbed						AP1101	87,02 €	
	Front Pyramide front pyramid						AP1102	87,02 €	
	Front Wabe front honeycomb						AP1103	87,02 €	
	Front Eiskristall front cracked ice						AP1104	87,02 €	
	Front Weiß front white						AP1105	87,02 €	
	Front Echtglasspiegel front genuine glass mirror						AP1106	109,92 €	
	Front Grau front grey						AP1107	87,02 €	
	Front fluoreszierend Grün front fluorescent green						AP1108	87,02 €	
	Front individueller Foliendruck front individual foil print						AP1199	206,09 €	

CAVITY Wall

CAVITY Wall setzt sanfte Lichtakzente auf der Wand und ergänzt die Produktfamilie um eine gleichseitig nach oben und unten abstrahlende Wandleuchte. Speziell konzipierte, kurvenförmige Aluminiumkörper und das vertieft darin sitzende Leuchtmittel erlauben eine freie Entfaltung des Lichts, das über die Trichterform scheinbar nach außen fließt. Unterschiedliche Beleuchtungsaufgaben können einheitlich durch Kombination der Wandleuchten mit Aufbau- und Einbaustrahlern sowie den Pendelleuchten dieser Produktfamilie gelöst werden.

CAVITY Wall sets gentle light accents on the wall and extends the product family with a wall luminaire distributing light equally upwards and downwards. Specially designed, curved aluminum bodies and the recessed illuminant within allow the light to unfold freely, seemingly flowing outwards via the funnel shaped form. Different lighting tasks can be solved consistently by combining the wall luminaires with surface-mounted and recessed spotlights and the pendant luminaires of this product family.

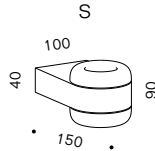

Licht
light **nach oben und unten gerichtet, seitlich abgeschirmt**
directed upwards and downwards, shielded to the sides

Leuchtmittel
lamp **LED 19 W, CoB, CRI Ra>97 (R9>80), EEK/EEC E**

Leuchteneinheit
lighting unit **Aluminium schwarz oder weiß beschichtet**
aluminum black or white coated



Sonstiges
features **LED austauschbar**
LED exchangeable

CAVITY Wall S

Abbildung figure	Beschreibung description	Leuchtmittel lamp	Regelung control	Leistung power	CCT	Lumen lumen	Art.-Nr. art.-no.	€ netto CH excl. VAT	€ brutto CH incl. VAT
●	schwarz black	LED	TRIAC	19 W	2700 K	1790 lm	CA2401	329,75 €	
					3000 K	1880 lm	CA2402	329,75 €	
			DALI	19 W	2700 K	1790 lm	CA2411	357,23 €	
					3000 K	1880 lm	CA2412	357,23 €	
○	weiß white	LED	TRIAC	19 W	2700 K	1790 lm	CA2405	329,75 €	
					3000 K	1880 lm	CA2406	329,75 €	
			DALI	19 W	2700 K	1790 lm	CA2415	357,23 €	
					3000 K	1880 lm	CA2416	357,23 €	

CLUB Wall

Diese Familie zeitlos klassischer Schirmleuchten ist für den anspruchsvollen Bedarf optimiert. Statt eines Drahtgestells halten schlanke Aluminiumprofile den Schirm – und vermeiden unschöne Schattenkanten.

This family of timeless classical lamps with shades has been improved to satisfy sophisticated demands. Instead of a wire frame, slender aluminum profiles hold shade, avoiding unsightly shadow lines.

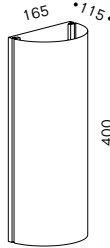

Licht light	nach oben und unten direkt, gerichtet, diffus durch Schirm directly up- and downwards, directional, diffuse through shade
Leuchtmittel lamp	LED R7s 15 W, CRI Ra>80 EEK/EEC E
Material material	Aluminium gebürstet oder schwarz lackiert; Schirm: Chintz weiß oder Melange grau aluminium brushed or black coated; shade: chintz white or melange grey
Sonstiges features	LED-Retrofit in Lieferung enthalten LED-Retrofit Included in delivery

CLUB Wall

Abbildung figure	Beschreibung description	Leuchtmittel lamp	Regelung control	Leistung power	CCT	Lumen lumen	Art.-Nr. art.-no.	€ netto CH excl. VAT	€ brutto CH incl. VAT
	gebürstet, Chintz weiß brushed, Chintz white	LED	TRIAC	15 W	2700 K	2000 lm	CL1075	265,63 €	
	schwarz, Chintz weiß black, Chintz white	LED	TRIAC	15 W	2700 K	2000 lm	CL1065	265,63 €	
	gebürstet, Melange grau brushed, Melange grey	LED	TRIAC	15 W	2700 K	2000 lm	CL2131	265,63 €	
	schwarz, Melange grau black, Melange grey	LED	TRIAC	15 W	2700 K	2000 lm	CL2132	265,63 €	

CRIB Wall

Im ausgeschalteten Zustand ist CRIB ein formal extrem reduziertes Wandobjekt aus einem schlichten Metallkörper und einer transparenten Glasfläche. Erst im eingeschalteten Zustand offenbart sich die Raffinesse des Glaselements, über dessen polierte Kante das LED-Licht eingespeist wird: Eine feine, speziell behandelte Echtglasscheibe lenkt das Licht gleichmäßig nach oben und unten. CRIB kann umgedreht, horizontal oder vertikal montiert werden und sorgt als Solitär oder in der Reihung für eine magische Lichtwirkung in minimalistischer Form.



When switched off, CRIB is a formally extremely reduced wall object made up of a simple metal body and a transparent glass surface. It is only when switched on that the sophistication of the glass element is revealed, as LED light is supplied via its polished edge: A delicate, specially treated pane of glass distributes the light evenly upwards and downwards. CRIB may be installed upside down, vertically or horizontally, and with its minimalist form creates a magical light effect both when used as a single luminaire or in a row.

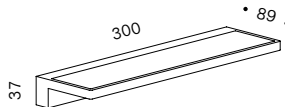

Licht light	nach oben und unten gestreut upwards and downwards diffuse
Leuchtmittel lamp	LED 12 W, CRI Ra>90, R9>50, EEK/EEC E
Material material	Gehäuse: Aluminium schwarz oder weiß beschichtet, Edelstahl finish oder Chrom finish; Lampenabdeckung: Optiwhite Echtglas mit Mikrostruktur housing: aluminium black or white coated, stainless steel finish or chrome finish; lamp cover: optiwhite glass with microstructure
Sonstiges features	LED austauschbar; kann als Up- oder Downlight montiert werden; IP44 Varianten sind nur für Innenräume geeignet LED exchangeable; can be mounted upwards or downwards; IP44 variants are only suitable for indoor use

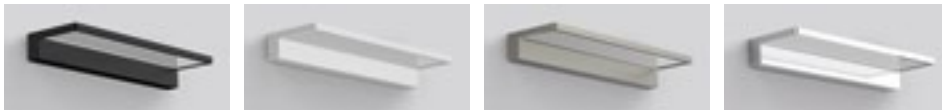

CRIB Wall

Abbildung figure	Beschreibung description	Leuchtmittel lamp	Regelung control	Leistung power	CCT	Lumen lumen	Art.-Nr. art.-no.	€ netto CH excl. VAT	€ brutto CH incl. VAT
●	schwarz black	LED	TRIAC	12 W	2700 K	1350 lm	CR1001	403,03 €	
○	weiß white	LED	TRIAC	12 W	2700 K	1350 lm	CR1002	403,03 €	
●	Edelstahl finish stainless steel finish	LED	TRIAC	12 W	2700 K	1350 lm	CR1003	448,82 €	
●	Chrom finish chrome finish	LED	TRIAC	12 W	2700 K	1350 lm	CR1005	448,82 €	

CRIB Wall IP44

Abbildung figure	Beschreibung description	Leuchtmittel lamp	Regelung control	Leistung power	CCT	Lumen lumen	Art.-Nr. art.-no.	€ netto CH excl. VAT	€ brutto CH incl. VAT
●	schwarz black	LED	TRIAC	12 W	2700 K	1350 lm	CR1101	439,66 €	
○	weiß white	LED	TRIAC	12 W	2700 K	1350 lm	CR1102	439,66 €	
●	Edelstahl finish stainless steel finish	LED	TRIAC	12 W	2700 K	1350 lm	CR1103	494,62 €	
●	Chrom finish chrome finish	LED	TRIAC	12 W	2700 K	1350 lm	CR1104	494,62 €	

CURLING Wall

CURLING Wall ergänzt die Produktfamilie um eine Wandleuchte, die für ein atmosphärisches Rundumlicht sorgt und so zum prägnanten Lichtobjekt wird. Ein spezieller Diffusor erzeugt ein dekoratives Lichtspiel der mundgeblasenen Glas- und handpolierten Metalloberflächen und macht die Leuchte zugleich blendfrei. Versionen mit Acrylglasschirm in kantiger Ästhetik erweitert das Einsatzspektrum von CURLING und ermöglichen einen optimalen Einsatz in Schulen, Kindergärten, Treppenhäusern und anderen Verkehrswegen im halböffentlichen oder öffentlichen Raum.

INNOVATIONSPREIS
ARCHITEKTUR +
TECHNIK
2020 AUSZEICHNUNG

CURLING Wall extends the product family to include a wall-mounted luminaire that delivers atmospheric all-round light and thus functions as a striking light sculpture. A special diffuser creates decoratively playful light thanks to the handblown glass and hand-polished metal surfaces, and also ensures the luminaire is glare-free. Versions with acrylic glass shade in angular aesthetics expand CURLING's range of applications and enable optimal use in schools, kindergartens, stairwells and other paths in semi-public and public spaces.

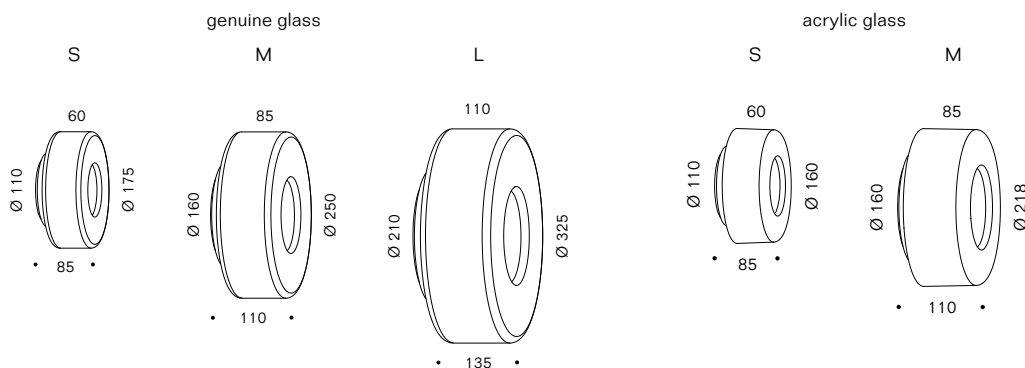

Leuchtmittel lamp LED 11–20 W, CoB, CRI Ra>97 (R9>80), EEK/EEC F (2700 K, 3000 K), G (1800–3000 K D2W)

Leuchteneinheit Lighting unit Aluminium hochglanzpoliert aluminum highly polished

Schirm shade mundgeblasenes Glas klar oder metallisiert
Diffusor: Polycarbonat, PMMA
hand-blown glass clear or metallised
diffuser: polycarbonate, PMMA

Acrylglass klar
Reflektor: Polycarbonat, PMMA
Acrylic glass clear
reflector: polycarbonate, PMMA

Ausführungen versions



Glasschirm klar
Licht: nach vorne diffus, rundum abstrahlend
glass shade clear
light: diffuse to the front, distributed all around



Acrylglasschirm klar
Licht: nach vorne diffus, rundum abstrahlend
acrylic glass shade clear
light: diffuse to the front, distributed all around







Glasschirm neusilber
Licht: nach vorne diffus, rundum abstrahlend
glass shade new silver
light: diffuse to the front, distributed all around





Sonstiges features LED wechselbar, werkzeuglose Schirmmontage; 110 V-Varianten auf Anfrage;
DALI-Varianten für den Einsatz in Notbeleuchtungsanlagen auf Anfrage
LED exchangeable, shade tool-free mountable; 110 V versions on request;
DALI versions for the use in emergency lighting systems on request

CURLING ist ein modularer Artikel. Bitte jeweils Leuchteneinheit und Glasschirm zusammen bestellen.
CURLING is a modular article. Please order the lighting unit and glass shade together.



CURLING Wall S

Abbildung figure	Beschreibung description	Leuchtmittel lamp	Regelung control	Leistung power	CCT	Lumen lumen	Art.-Nr. art.-no.	€ netto CH excl. VAT	€ brutto CH incl. VAT
	Leuchteneinheit S lighting unit S	LED	TRIAC	11 W	2700 K	1130 lm	LE015701	196,93 €	
					3000 K	1180 lm	LE015702	196,93 €	
					1800 K–3000 K D2W	870 lm	LE015703	233,57 €	
			DALI	11 W	2700 K	1130 lm	LE015730	224,41 €	
					3000 K	1180 lm	LE015731	224,41 €	
					1800 K–3000 K D2W	870 lm	LE015732	261,05 €	
	Glas S klar glass S clear					CU011212	219,83 €		
	Glas S neusilber glass shade S new silver					CU011218	306,89 €		
	Acrylglas S klar acrylic glass S clear					CU011220	109,92 €		

CURLING Wall M

Abbildung figure	Beschreibung description	Leuchtmittel lamp	Regelung control	Leistung power	CCT	Lumen lumen	Art.-Nr. art.-no.	€ netto CH excl. VAT	€ brutto CH incl. VAT
	Leuchteneinheit M lighting unit M	LED	TRIAC	20 W	2700 K	1910 lm	LE015710	261,05 €	
					3000 K	2010 lm	LE015711	261,05 €	
					1800 K–3000 K D2W	1540 lm	LE015712	297,69 €	
			DALI 1–10 V	20 W	2700 K	1910 lm	LE015713	288,53 €	
					3000 K	2010 lm	LE015714	288,53 €	
					1800 K–3000 K D2W	1540 lm	LE015715	325,17 €	
	Glas M klar glass M clear					CU011209	256,47 €		
	Glas M neusilber glass shade M new silver					CU011219	366,41 €		
	Acrylglas M klar acrylic glass M clear					CU011223	137,39 €		

CURLING Wall L

Abbildung figure	Beschreibung description	Leuchtmittel lamp	Regelung control	Leistung power	CCT	Lumen lumen	Art.-Nr. art.-no.	€ netto DE excl. VAT	€ brutto CH incl. VAT
	Leuchteneinheit L lighting unit L	LED	TRIAC	34 W	2700 K	3360 lm	LE014480	316,01 €	
					3000 K	3480 lm	LE014483	316,01 €	
			DALI	34 W	2700 K	3360 lm	LE014478	343,49 €	
					3000 K	3480 lm	LE014481	343,49 €	
	Glas L klar glass L clear					CU011210	366,39 €		
	Glas L neusilber glass L new silver					CU011224	462,56 €		

CURLING Wall – Zubehör / Accessories

Optiken optics	Einfach austauschbare Optiken zur Bestimmung der Lichtverteilung von CURLING Wall finden Sie auf Seite 201. Easily replaceable optics to define the light distribution of CURLING Wall, see page 201.
-------------------	--

LID Wall

Bei Tag ist LID ein dezentes Designobjekt. Sobald man LID einschaltet, verwandelt sie sich in sphärisches Licht. Einen besonderen Akzent setzt eine feine Lichtaura, durch die sich die kreisrunde Scheibe von dem sie umgebenden Lichtschein abhebt. LID löst sich optisch vom Hintergrund und entfaltet eine angenehme, ruhige Lichtstimmung.



During the day LID is a discreet design object but as soon as LID is turned on, it morphs into spherical light. The fine aura of light that emanates through the circular disc is particularly eye-catching and sets it off from the surrounding shining light. LID stands out from the backgrounds and contributes to a pleasant, calm and light mood.

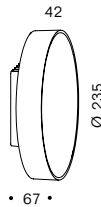

Licht light	rundum gleichmäßig abstrahlend radiating evenly right round
-----------------------	---





Leuchtmittel lamp	LED 16–22 W, CRI Ra>90, EEK/EEC E
-----------------------------	-----------------------------------

Material material	Kühlkörper: Aluminium, Schirm: Plexiglas® transparent; Front: Glas opal, Spiegelglas, Aluminium silber eloxiert, Aluminium champagner eloxiert cooling unit: aluminium; housing: transparent Plexiglas®; front: opal glass, mirror glass, aluminium silver or gold anodized
-----------------------------	--







Sonstiges features	LED austauschbar LED exchangeable
------------------------------	---

LID Wall

Abbildung figure	Beschreibung description	Leuchtmittel lamp	Regelung control	Leistung power	CCT	Lumen lumen	Art.-Nr. art.-no.	€ netto CH excl. VAT	€ brutto CH incl. VAT
	Leuchteneinheit LID lighting unit LID	LED	TRIAC	16 W	2700 K	1880 lm	LD1001	334,33 €	
					3000 K	1880 lm	LD1002	334,33 €	
			DALI	22 W	2700 K	2690 lm	LD1005	370,97 €	
					3000 K	2690 lm	LD1006	370,97 €	
	Front Aluminium champagner eloxiert front aluminium champagne anodized						LD1103	105,34 €	
	Front Aluminium silber eloxiert front aluminium silver anodized						LD1104	105,34 €	
	Front Echtglas opal front genuine glass opal						LD1101	146,55 €	
	Front Spiegel front genuine glass mirror						LD1102	146,55 €	

LID Wall IP44

Abbildung figure	Beschreibung description	Leuchtmittel lamp	Regelung control	Leistung power	CCT	Lumen lumen	Art.-Nr. art.-no.	€ netto CH excl. VAT	€ brutto CH incl. VAT
	Leuchteneinheit LID IP44 lighting unit LID IP44	LED	TRIAC	16 W	2700 K	1880 lm	LD1201	370,97 €	
					3000 K	1880 lm	LD1202	370,97 €	
			DALI	22 W	2700 K	2690 lm	LD1205	398,45 €	
					3000 K	2690 lm	LD1206	398,45 €	
	IP44 Front Aluminium champagner eloxiert front aluminium champagne anodized						LD1303	128,24 €	
	IP44 Front Aluminium silber eloxiert front aluminium silver anodized						LD1304	128,24 €	
	IP44 Front Echtglas opal front genuine glass opal						LD1301	164,87 €	
	IP44 Front Spiegel front genuine glass mirror						LD1302	164,87 €	

POPPY Wall

Werden die „Mohnblüten“ dieser Familie durch Einschalten geweckt, öffnen sich ihre Schirme ganz allmählich: die feinen Blätter sind aus Bimetall und dehnen sich durch Erwärmung aus. Alle Varianten können nach Belieben umgestaltet werden. Der flexible, textilmantelte Schlauch lässt sich immer neu biegen – zur Änderung der Lichtrichtung, oder einfach weil Ihnen danach ist. Die mundgeblasenen Glaskapseln sind erhältlich in den Farben keramik, rubinrot oder violett.

When the “poppy flowers” in this family are woken by the lamp being switched on, their shades open very gradually: the delicate leaves are bi-metallic and expand when heated. All the versions can be reshaped as desired. The flexible, textile-coated stem can be bent at will, to change the direction of the light, or because you just feel like it. The hand-blown glass capsules are available in ceramic, ruby red or violet.

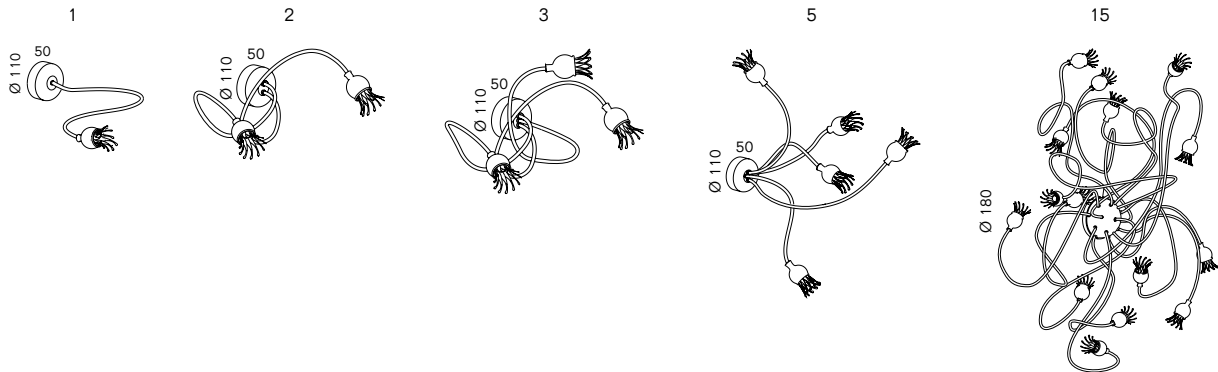







Licht light	nach vorne gerichtet, seitlich abgeschirmt directed forward, shielded to the sides
Leuchtmittel lamp	POPPY Wall 1/2/3: 1×2×3×G4 35 W, 12 V, EEK/EEC G POPPY Wall 5/15: 5×15×G4 20 W, 12 V, EEK/EEC G
Größen sizes	1 bis 5 Arme: Länge der Arme 75 cm, 15 Arme: Länge der Arme 75 oder 150 cm 1 to 5 arms: length of arms 75 cm, 15 arms: length of arms 75 cm or 150 cm
Material material	Arme, flexibel: Aluminium, textilmantelt beige oder schwarz; Glasschirme: mundgeblasenes Glas keramik, rubinrot oder violett; Lamellen: Bimetall; Baldachin: 1–5 Arme Edelstahl, poliert; 15 Arme: Edelstahl gebürstet arms, flexible: textile coated aluminium tube in beige or black; glass shade: hand-blown glass in ceramic, ruby red or violet; lamellae: bimetal; canopy: 1–5 arms stainless steel, polished; 15 arms: stainless steel, brushed
Sonstiges features	Leuchtmittel in Lieferung enthalten; Reflektor-Lamellen öffnen sich nach ca. 2 Minuten Betriebszeit; Leuchte kann auch als Deckenleuchte montiert werden lamps included in delivery; lamellae open within approx. 2 minutes after switching on luminaire; luminaire can also be mounted as ceiling luminaire







POPPY Wall 1

Abbildung figure	Beschreibung description	Fassung socket	Regelung control	Leistung power	Art.-Nr. art.-no.	€ netto CH excl. VAT	€ brutto CH incl. VAT
	1 Arm schwarz, Schirm keramik 1 arm black, shade ceramic	G4	ON/OFF	max. 35 W	PO1025	430,50 €	
	1 Arm schwarz, Schirm rubinrot 1 arm black, shade ruby red	G4	ON/OFF	max. 35 W	PO1026	430,50 €	
	1 Arm schwarz, Schirm violett 1 arm black, shade violet	G4	ON/OFF	max. 35 W	PO1027	430,50 €	
	1 Arm beige, Schirm keramik 1 arm beige shade ceramic	G4	ON/OFF	max. 35 W	PO1028	430,50 €	
	1 Arm beige, Schirm rubinrot 1 arm beige shade ruby red	G4	ON/OFF	max. 35 W	PO1029	430,50 €	
	1 Arm beige, Schirm violett 1 arm beige shade violet	G4	ON/OFF	max. 35 W	PO1030	430,50 €	







POPPY Wall 2

Abbildung figure	Beschreibung description	Fassung socket	Regelung control	Leistung power	Art.-Nr. art.-no.	€ netto CH excl. VAT	€ brutto CH incl. VAT
	2 Arme schwarz, Schirme keramik 2 arms black, shades ceramic	2 × G4	ON/OFF	max. 70 W	PO1031	540,42 €	
	2 Arme schwarz, Schirme rubinrot 2 arms black, shades ruby red	2 × G4	ON/OFF	max. 70 W	PO1032	540,42 €	
	2 Arme schwarz, Schirme violett 2 arms black, shades violet	2 × G4	ON/OFF	max. 70 W	PO1033	540,42 €	
	2 Arme beige, Schirme keramik 2 arms beige shades ceramic	2 × G4	ON/OFF	max. 70 W	PO1034	540,42 €	
	2 Arme beige, Schirme rubinrot 2 arms beige shades ruby red	2 × G4	ON/OFF	max. 70 W	PO1035	540,42 €	
	2 Arme beige, Schirme violett 2 arms beige shades violet	2 × G4	ON/OFF	max. 70 W	PO1036	540,42 €	







POPPY Wall 3

Abbildung figure	Beschreibung description	Fassung socket	Regelung control	Leistung power	Art.-Nr. art.-no.	€ netto CH excl. VAT	€ brutto CH incl. VAT
	3 Arme schwarz, Schirme keramik 3 arms black, shades ceramic	3 × G4	ON/OFF	max. 105 W	PO1037	650,34 €	
	3 Arme schwarz, Schirme rubinrot 3 arms black, shades ruby red	3 × G4	ON/OFF	max. 105 W	PO1038	650,34 €	
	3 Arme schwarz, Schirme violett 3 arms black, shades violet	3 × G4	ON/OFF	max. 105 W	PO1039	650,34 €	
	3 Arme beige, Schirme keramik 3 arms beige shades ceramic	3 × G4	ON/OFF	max. 105 W	PO1040	650,34 €	
	3 Arme beige, Schirme rubinrot 3 arms beige shades ruby red	3 × G4	ON/OFF	max. 105 W	PO1041	650,34 €	
	3 Arme beige, Schirme violett 3 arms beige shades violet	3 × G4	ON/OFF	max. 105 W	PO1042	650,34 €	

POPPY Wall 5

Abbildung figure	Beschreibung description	Fassung socket	Regelung control	Leistung power	Art.-Nr. art.-no.	€ netto CH excl. VAT	€ brutto CH incl. VAT
	5 Arme schwarz, Schirme keramik 5 arms black, shades ceramic	5 × G4	ON/OFF	max. 100 W	PO1043	842,69 €	
	5 Arme schwarz, Schirme rubinrot 5 arms black, shades ruby red	5 × G4	ON/OFF	max. 100 W	PO1044	842,69 €	
	5 Arme schwarz, Schirme violett 5 arms black, shades violet	5 × G4	ON/OFF	max. 100 W	PO1045	842,69 €	
	5 Arme beige, Schirme keramik 5 arms beige shades ceramic	5 × G4	ON/OFF	max. 100 W	PO1046	842,69 €	
	5 Arme beige, Schirme rubinrot 5 arms beige shades ruby red	5 × G4	ON/OFF	max. 100 W	PO1047	842,69 €	
	5 Arme beige, Schirme violett 5 arms beige shades violet	5 × G4	ON/OFF	max. 100 W	PO1048	842,69 €	

POPPY Wall 15

Abbildung figure	Beschreibung description	Fassung socket	Regelung control	Leistung power	Art.-Nr. art.-no.	€ netto CH excl. VAT	€ brutto CH incl. VAT
	15 Arme 75 cm schwarz, Schirme keramik 15 arms 75 cm black, shades ceramic	15 × G4	ON/OFF	max. 300 W	PO1007	1.923,53 €	
	15 Arme 150 cm schwarz, Schirme keramik 15 arms 150 cm black, shades ceramic	15 × G4	ON/OFF	max. 300 W	PO1010	2.015,13 €	
	15 Arme 75 cm schwarz, Schirme rubinrot 15 arms 75 cm black, shades ruby red	15 × G4	ON/OFF	max. 300 W	PO1008	1.923,53 €	
	15 Arme 150 cm schwarz, Schirme rubinrot arms 150 cm black, shades ruby red	15 × G4	ON/OFF	max. 300 W	PO1011	2.015,13 €	
	15 Arme 75 cm schwarz, Schirme violett 15 arms 75 cm black, shades violet	15 × G4	ON/OFF	max. 300 W	PO1009	1.923,53 €	
	15 Arme 150 cm schwarz, Schirme violett 15 arms 150 cm black, shades violet	15 × G4	ON/OFF	max. 300 W	PO1012	2.015,13 €	
	15 Arme 75 cm beige, Schirme keramik 15 arms 75 cm beige, shades ceramic	15 × G4	ON/OFF	max. 300 W	PO1013	1.923,53 €	
	15 Arme 150 cm beige, Schirme keramik 15 arms 150 cm beige, shades ceramic	15 × G4	ON/OFF	max. 300 W	PO1016	2.015,13 €	
	15 Arme 75 cm beige, Schirme rubinrot 15 arms 75 cm beige, shades ruby red	15 × G4	ON/OFF	max. 300 W	PO1014	1.923,53 €	
	15 Arme 150 cm beige, Schirme rubinrot 15 arms 150 cm beige, shades ruby red	15 × G4	ON/OFF	max. 300 W	PO1017	2.015,13 €	
	15 Arme 75 cm beige, Schirme violett 15 arms 75 cm beige, shades violet	15 × G4	ON/OFF	max. 300 W	PO1015	1.923,53 €	
	15 Arme 150 cm beige, Schirme violett 15 arms 150 cm beige, shades violet	15 × G4	ON/OFF	max. 300 W	PO1018	2.015,13 €	

REEF Wall

Die unverwechselbaren Leuchtschirme dieser Familie bestehen aus innovativer Schaumkeramik, deren Struktur stark an Korallen erinnert. Dabei sind sie durabel, spülmaschinentauglich und verteilen das Streulicht perfekt in einem sanften Bone China-Farbton. Die zylindrischen Körper sind einseitig offen – so strahlen die Leuchten dieser Familie kräftig und brillant, aber völlig blendfrei.

The unmistakable lamp shades in this family are made of innovative foam ceramic, whose texture is highly reminiscent of corals. That said they are durable, dishwasher-proof and distribute the scattered light perfectly in a gentle bone china hue. The cylindrical objects are open on one side, such that the lamps in this family shine powerfully and brightly, though without any glare at all.



reddot design award
winner 2004

DESIGN PLUS

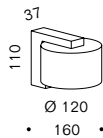

downlight

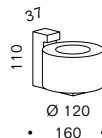

uplight

Licht light	nach unten gerichtet, rundum diffus directed downwards, diffuse all around
Leuchtmittel lamp	LED 8 W, CoB, CRI Ra>97, EEK/EEC F G9 max. 60 W, EEK/EEC G
Gehäuse Housing	Aluminium poliert oder gebürstet; Leuchtschirm: Keramikschaum weiß aluminium polished or brushed; shade: ceramic foam white
Sonstiges features	Schirm werkzeuglos abnehmbar und spülmaschinenfest; LED austauschbar; kann als Up- oder Downlight montiert werden shade tool-free removable and dishwasher safe; LED exchangeable; can be mounted upwards or downwards

REEF Wall

Abbildung figure	Beschreibung description	Leuchtmittel lamp	Regelung control	Leistung power	CCT	Lumen lumen	Art.-Nr. art.-no.	€ netto CH excl. VAT	€ brutto CH incl. VAT
●	gebürstet brushed	LED	TRIAC	8 W	2700 K	790 lm	RF2057	421,34 €	
		G9	TRIAC	max. 60 W	2700 K	740 lm	RF1002	316,01 €	
●	poliert polished	LED	TRIAC	8 W	2700 K	790 lm	RF2058	448,82 €	
		G9	TRIAC	max. 60 W	2700 K	740 lm	RF1001	338,91 €	

REFLEX² Wall

REFLEX² Wall reduziert die Formensprache der Produktfamilie auf das Wesentliche und komplettiert sie mit einer extrem flachen Wandleuchte. REFLEX² Wall greift als Uplight das Prinzip der indirekten Beleuchtung auf, die intensives, weiches Licht über Decke und Wand in den Raum strahlt und so für ein absolut blendfreies Licht im Büro, in Privaträumen oder im Objektbereich sorgt.

REFLEX² Wall reduces the design language of the product family to the essentials and completes it with an extremely flat wall luminaire. As an uplight, REFLEX² Wall picks up on the principle of indirect lighting, emitting intense, soft light into the room via the ceiling and wall, thus providing absolutely glare-free light for offices, private rooms and more extensive projects.

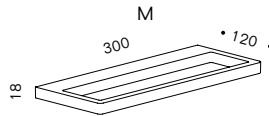

Licht
light **nach oben oder unten gerichtet, indirekt über Wand und Decke**
directed upwards, indirectly via wall and ceiling

Leuchtmittel
lamp **LED 12 W, CRI Ra>90 (R9>50), EEK/EEC E**

Gehäuse
housing **Aluminium schwarz oder weiß beschichtet**
aluminium black or white coated

Material
material **Leuchtmittelabdeckung: Flachglas satinée**
lamp cover: glass semigloss



Sonstiges
features **LED austauschbar; kann als Up- oder Downlight montiert werden**
LED exchangeable; can be mounted upwards or downwards

REFLEX² Wall M

Abbildung figure	Beschreibung description	Leuchtmittel lamp	Regelung control	Leistung power	CCT	Lumen lumen	Art.-Nr. art.-no.	€ netto CH excl. VAT	€ brutto CH incl. VAT
●	schwarz black	LED	TRIAC	12 W	2700 K	1420 lm	RE4001	348,07 €	
					3000 K	1470 lm	RE4003	348,07 €	
○	weiß white	LED	TRIAC	12 W	2700 K	1420 lm	RE4002	348,07 €	
					3000 K	1470 lm	RE4004	348,07 €	

REFLEX² Wall M – Zubehör / Accessories

Wandabdeckungen Zur Abdeckung von z. B. Anschlussdosen finden Sie passende Wandabdeckungen auf Seite 203.
Wall covers To cover e.g. junction boxes wall matching covers can be found on page 203.

ROD Wall

Mit einem reduzierten Glaskörper in einem abgerundeten, kubischen Glasprofil erhält ROD die Anmutung einer minimalistischen Wandvitrine. Aufgrund ihres leichten Wandabstands wird sie zur schwebenden, fast schon architektonischen vertikalen Struktur. Mit einem illuminierten Innenkörper und den unterschiedlichen Innenschirmen lassen sich verschiedene Lichtszenarien schaffen.



With its reduced glass body in a rounded, cubic glass profile, ROD appears like a minimalist display cabinet mounted on the wall. The slight gap between the luminaire and the wall turns it into a floating, almost architectural vertical structure. Various lighting scenarios may be created with the illuminated inner body and the very different inner shades.



Licht
light **direkt nach oben und unten, nach vorne diffus oder abgeschirmt**
directed upwards and downwards, forwards diffuse or shielded

Leuchtmittel
lamp **LED 27 W, CRI Ra>90, R9>50, EEK/EEC F**

Gehäuse
Housing **Glasschirm: Borosilikatglasrohr; Gehäuse: Aluminium weiß beschichtet**
glass shade: borosilicate glass tube; body: aluminium white coated

Innenschirm
inner shade **Acrylglas opal, Aluminium glanzverchromt oder gold eloxiert**
acrylic satinée opal, aluminium chrome plated or gold anodized



Sonstiges
features **LED austauschbar; weitere Ausführungen (CCT/CRI) und andere Oberflächen auf Anfrage erhältlich.**
LED exchangeable; other versions (CCT/CRI) and different coatings available on request.

ROD Wall

Abbildung figure	Beschreibung description	Leuchtmittel lamp	Regelung control	Leistung power	CCT	Lumen lumen	Art.-Nr. art.-no.	€ netto CH excl. VAT	€ brutto CH incl. VAT
○	opal opal	LED	TRIAC 0–10 V	27 W	2700 K	3180 lm	RD1001	512,94 €	
			DALI	27 W	2700 K	3180 lm	RD1009	540,42 €	
●	glanzverchromt chrome plated	LED	TRIAC 0–10 V	27 W	2700 K	3180 lm	RD1002	512,94 €	
			DALI	27 W	2700 K	3180 lm	RD1010	540,42 €	
●	gold eloxiert gold anodized	LED	TRIAC 0–10 V	27 W	2700 K	3180 lm	RD1018	512,94 €	
			DALI	27 W	2700 K	3180 lm	RD1021	540,42 €	

SML Wall

Als Baukastensystem konzipiert, bietet das SML-Programm eine Fülle an Einsatzmöglichkeiten. Konsequente Gestaltung hat seine Abmessungen auf das Minimum reduziert: 25 mm Bauhöhe. Die für oben und unten frei wählbaren unterschiedlichen Leuchtmittelabdeckungen ermöglichen eine individuelle Lichtlenkung – symmetrisch nach oben und unten streuend oder zu einer Seite abgeblendet. So können repräsentative Büros oder Wohnungen in einer einheitlichen Formensprache beleuchtet werden, ohne dabei auf unterschiedliche Lichtqualitäten verzichten zu müssen.

Conceived as a modular system, the SML range can be used for a variety of purposes. A consistent design has pared its dimensions down to a minimum: 25 mm in height. The different illuminant covers, which can be chosen freely for top and bottom, allow the light to be directed individually – symmetrically scattering upward and downward or shielded to one side. This way, for example, prestigious offices and apartments can be illuminated in a uniform formal language, without having to do without differing qualities of light.

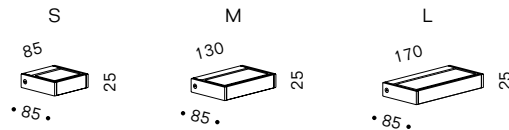

Licht light	Abhängig von gewählter Leuchtmittelabdeckung symmetrisch nach oben und unten gestreut oder zu einer Seite gestreut, zur anderen abgeblendet depending on the chosen illuminant covers symmetrical scattering upward and downward or scattered to one side, dimmed to the other
-----------------------	--

Leuchtmittel lamp	S: 60 W G9, EEK/EEC G M: 120 W R7s, EEK/EEC G L: 160 W R7s, EEK/EEC G
-----------------------------	---





Material material	Aluminium eloxiert silber oder Aluminium glanzverchromt, Leuchtmittelabdeckungen: Keramikglas aluminum anodized silver or aluminum chrome-plated, bulb covers: ceramic glass
-----------------------------	--

SML Wall – Zubehör / Accessories





Wandabdeckungen Wall covers	Zur Abdeckung von z. B. Anschlussdosen finden Sie passende Wandabdeckungen auf Seite 203. To cover e.g. junction boxes wall matching covers can be found on page 203.
---------------------------------------	---







SML Wall S

Abbildung figure	Beschreibung description	Fassung socket	Regelung control	Leistung power	Art.-Nr. art.-no.	€ netto CH excl. VAT	€ brutto CH incl. VAT
	silber, satinée/satinée silver, satinée/satinée	G9	TRIAC	max. 60 W	SM1172	265,63 €	
	silber, satinée/Raster silver, satinée/raster	G9	TRIAC	max. 60 W	SM1199	265,63 €	
	glanzverchromt, satinée/satinée chrome plated, satinée/satinée	G9	TRIAC	max. 60 W	SM3172	297,69 €	
	glanzverchromt, satinée/Raster chrome plated, satinée/raster	G9	TRIAC	max. 60 W	SM3199	297,69 €	

SML Wall M

Abbildung figure	Beschreibung description	Fassung socket	Regelung control	Leistung power	Art.-Nr. art.-no.	€ netto CH excl. VAT	€ brutto CH incl. VAT
	silber, satinée/satinée silver, satinée/satinée	R7s	TRIAC	max. 120 W	SM1173	283,95 €	
	silber, satinée/Raster silver, satinée/raster	R7s	TRIAC	max. 120 W	SM1198	283,95 €	
	glanzverchromt, satinée/satinée chrome plated, satinée/satinée	R7s	TRIAC	max. 120 W	SM3173	320,59 €	
	glanzverchromt, satinée/Raster chrome plated, satinée/raster	R7s	TRIAC	max. 120 W	SM3177	320,59 €	

SML Wall L

Abbildung figure	Beschreibung description	Fassung socket	Regelung control	Leistung power	Art.-Nr. art.-no.	€ netto CH excl. VAT	€ brutto CH incl. VAT
	silber, satinée/satinée silver, satinée/satinée	R7s	TRIAC	max. 160 W	SM1174	311,43 €	
	silber, satinée/Raster silver, satinée/raster	R7s	TRIAC	max. 160 W	SM1175	311,43 €	
	glanzverchromt, satinée/satinée chrome plated, satinée/satinée	R7s	TRIAC	max. 160 W	SM3174	352,65 €	
	glanzverchromt, satinée/Raster chrome plated, satinée/raster	R7s	TRIAC	max. 160 W	SM3176	352,65 €	

SML² Wall

Mit ihrem radikal reduzierten Design und exklusiver Ausstattung hat sich die SML-Familie als ein Markenzeichen des Unternehmens etabliert. Die SML²-Linie eröffnet mit sechs Größenausführungen erweiterte Einsatzmöglichkeiten und Modularität. Auch SML² ist mit nur 25 mm Bauhöhe modular kombinierbar mit allen anderen Versionen.

With its radically reduced design and exclusive features, the SML line has established itself as one of the series trademark ranges. The SML² line comes in six lengths and offers wide application range and extended modularity. With its height of just 25 mm SML² can be modularly combined with all other versions.

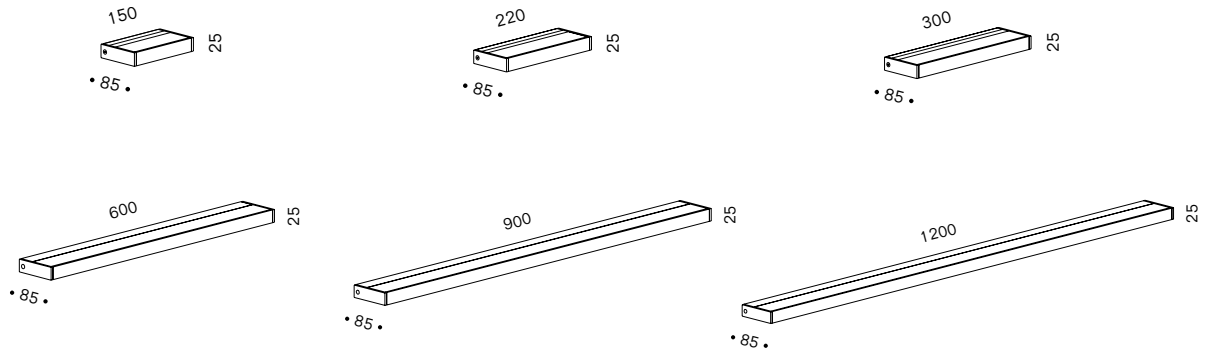









Licht light	Abhängig von gewählter Leuchtmittelabdeckung symmetrisch nach oben und unten gestreut oder zu einer Seite gestreut, zur anderen abgeblendet depending on the chosen illuminant covers symmetrical scattering upward and downward or scattered to one side, dimmed to the other
Leuchtmittel lamp	LED 10–40 W, CRI Ra>90 (R9>50), EEK/EEC F
Material material	Aluminium poliert oder Aluminium schwarz, silber oder weiß lackiert; Leuchtmittelabdeckungen; Polycarbonat aluminium polished or aluminium lacquered black, silver or white; Illuminant covers: polycarbonate
Sonstiges features	LED austauschbar LED exchangeable









SML² Wall – Zubehör / Accessories

Wandabdeckungen Wall covers	Zur Abdeckung von z. B. Anschlussdosen finden Sie passende Wandabdeckungen auf Seite 203. To cover e.g. junction boxes wall matching covers can be found on page 203.
Wandadapter Wall adapters	Montagehilfe bei nicht mittigem Stromanschluss finden Sie auf Seite 202. Mounting aid for centered power connection can be found on page 202.









SML² Wall 150

Abbildung figure	Beschreibung description	Leuchtmittel lamp	Regelung control	Leistung power	CCT	Lumen lumen	Art.-Nr. art.-no.	€ netto CH excl. VAT	€ brutto CH incl. VAT
	silber, satinée/satinée silver, satinée/satinée	LED	ON/OFF	10 W	2700 K	1110 lm	SM1325	380,13 €	
					3000 K	1130 lm	SM1227	380,13 €	
	silber, satinée/Raster silver, satinée/raster	LED	ON/OFF	10 W	2700 K	1110 lm	SM1326	380,13 €	
					3000 K	1130 lm	SM1228	380,13 €	
	weiß, satinée/satinée white, satinée/satinée	LED	ON/OFF	10 W	2700 K	1110 lm	SM1327	380,13 €	
					3000 K	1130 lm	SM1229	380,13 €	
	weiß, satinée/Raster white, satinée/raster	LED	ON/OFF	10 W	2700 K	1110 lm	SM1328	380,13 €	
					3000 K	1130 lm	SM1230	380,13 €	
	schwarz, satinée/satinée black, satinée/satinée	LED	ON/OFF	10 W	2700 K	1110 lm	SM1329	380,13 €	
					3000 K	1130 lm	SM1231	380,13 €	
	schwarz, satinée/Raster black, satinée/raster	LED	ON/OFF	10 W	2700 K	1110 lm	SM1330	380,13 €	
					3000 K	1130 lm	SM1232	380,13 €	
	poliert, satinée/satinée polished, satinée/satinée	LED	ON/OFF	10 W	2700 K	1110 lm	SM1331	430,50 €	
					3000 K	1130 lm	SM1233	430,50 €	
	poliert, satinée/Raster polished, satinée/raster	LED	ON/OFF	10 W	2700 K	1110 lm	SM1332	430,50 €	
					3000 K	1130 lm	SM1234	430,50 €	









SML² Wall 220

Abbildung figure	Beschreibung description	Leuchtmittel lamp	Regelung control	Leistung power	CCT	Lumen lumen	Art.-Nr. art.-no.	€ netto CH excl. VAT	€ brutto CH incl. VAT
	silber, satinée/satinée silver, satinée/satinée	LED	TRIAC	15 W	2700 K	1540 lm	SM1333	476,30 €	
					3000 K	1560 lm	SM1235	476,30 €	
	silber, satinée/Raster silver, satinée/raster	LED	TRIAC	15 W	2700 K	1540 lm	SM1334	476,30 €	
					3000 K	1560 lm	SM1236	476,30 €	
	weiß, satinée/satinée white, satinée/satinée	LED	TRIAC	15 W	2700 K	1540 lm	SM1335	476,30 €	
					3000 K	1560 lm	SM1237	476,30 €	
	weiß, satinée/Raster white, satinée/raster	LED	TRIAC	15 W	2700 K	1540 lm	SM1336	476,30 €	
					3000 K	1560 lm	SM1238	476,30 €	
	schwarz, satinée/satinée black, satinée/satinée	LED	TRIAC	15 W	2700 K	1540 lm	SM1337	476,30 €	
					3000 K	1560 lm	SM1239	476,30 €	
	schwarz, satinée/Raster black, satinée/raster	LED	TRIAC	15 W	2700 K	1540 lm	SM1338	476,30 €	
					3000 K	1560 lm	SM1240	476,30 €	
	poliert, satinée/satinée polished, satinée/satinée	LED	TRIAC	15 W	2700 K	1540 lm	SM1339	522,10 €	
					3000 K	1560 lm	SM1241	522,10 €	
	poliert, satinée/Raster polished, satinée/raster	LED	TRIAC	15 W	2700 K	1540 lm	SM1340	522,10 €	
					3000 K	1560 lm	SM1242	522,10 €	









SML² Wall 300

Abbildung figure	Beschreibung description	Leuchtmittel lamp	Regelung control	Leistung power	CCT	Lumen lumen	Art.-Nr. art.-no.	€ netto CH excl. VAT	€ brutto CH incl. VAT
	silber, satinée/satinée silver, satinée/satinée	LED	TRIAC	20 W	2700 K	2090 lm	SM1341	577,06 €	
					3000 K	2130 lm	SM1243	577,06 €	
			DALI	20 W	2700 K	2090 lm	SM1601	604,54 €	
					3000 K	2130 lm	SM1602	604,54 €	
	silber, satinée/Raster silver, satinée/raster	LED	TRIAC	20 W	2700 K	2090 lm	SM1342	577,06 €	
					3000 K	2130 lm	SM1244	577,06 €	
			DALI	20 W	2700 K	2090 lm	SM1603	604,54 €	
					3000 K	2130 lm	SM1604	604,54 €	
	weiß, satinée/satinée white, satinée/satinée	LED	TRIAC	20 W	2700 K	2090 lm	SM1343	577,06 €	
					3000 K	2130 lm	SM1245	577,06 €	
			DALI	20 W	2700 K	2090 lm	SM1605	604,54 €	
					3000 K	2130 lm	SM1606	604,54 €	
	weiß, satinée/Raster white, satinée/raster	LED	TRIAC	20 W	2700 K	2090 lm	SM1344	577,06 €	
					3000 K	2130 lm	SM1246	577,06 €	
			DALI	20 W	2700 K	2090 lm	SM1607	604,54 €	
					3000 K	2130 lm	SM1608	604,54 €	
	schwarz, satinée/satinée black, satinée/satinée	LED	TRIAC	20 W	2700 K	2090 lm	SM1345	577,06 €	
					3000 K	2130 lm	SM1247	577,06 €	
			DALI	20 W	2700 K	2090 lm	SM1609	604,54 €	
					3000 K	2130 lm	SM1610	604,54 €	
	schwarz, satinée/Raster black, satinée/raster	LED	TRIAC	20 W	2700 K	2090 lm	SM1346	577,06 €	
					3000 K	2130 lm	SM1248	577,06 €	
			DALI	20 W	2700 K	2090 lm	SM1611	604,54 €	
					3000 K	2130 lm	SM1612	604,54 €	
	poliert, satinée/satinée polished, satinée/satinée	LED	TRIAC	20 W	2700 K	2090 lm	SM1347	622,86 €	
					3000 K	2130 lm	SM1249	622,86 €	
			DALI	20 W	2700 K	2090 lm	SM1613	650,34 €	
					3000 K	2130 lm	SM1614	650,34 €	
	poliert, satinée/Raster polished, satinée/raster	LED	TRIAC	20 W	2700 K	2090 lm	SM1348	622,86 €	
					3000 K	2130 lm	SM1250	622,86 €	
			DALI	20 W	2700 K	2090 lm	SM1615	650,34 €	
					3000 K	2130 lm	SM1616	650,34 €	

SML² Wall 600

Abbildung figure	Beschreibung description	Leuchtmittel lamp	Regelung control	Leistung power	CCT	Lumen lumen	Art.-Nr. art.-no.	€ netto CH excl. VAT	€ brutto CH incl. VAT
	silber, satinée/satinée silver, satinée/satinée	LED	TRIAC	20 W	2700 K	2050 lm	SM1701	577,06 €	
					3000 K	2080 lm	SM1801	577,06 €	
					2700 K	2050 lm	SM1349	577,06 €	
			DALI	20 W	3000 K	2080 lm	SM1251	577,06 €	
					2700 K–5000 K TW	2100 lm	SM1501	622,86 €	
	silber, satinée/Raster silver, satinée/raster	LED	TRIAC	20 W	2700 K	2050 lm	SM1702	577,06 €	
					3000 K	2080 lm	SM1802	577,06 €	
					2700 K	2050 lm	SM1350	577,06 €	
			DALI	20 W	3000 K	2080 lm	SM1252	577,06 €	
					2700 K–5000 K TW	2100 lm	SM1502	622,86 €	
	weiß, satinée/satinée white, satinée/satinée	LED	TRIAC	20 W	2700 K	2050 lm	SM1703	577,06 €	
					3000 K	2080 lm	SM1803	577,06 €	
					2700 K	2050 lm	SM1351	577,06 €	
			DALI	20 W	3000 K	2080 lm	SM1253	577,06 €	
					2700 K–5000 K TW	2100 lm	SM1503	622,86 €	
	weiß, satinée/Raster white, satinée/raster	LED	TRIAC	20 W	2700 K	2050 lm	SM1704	577,06 €	
					3000 K	2080 lm	SM1804	577,06 €	
					2700 K	2050 lm	SM1352	577,06 €	
			DALI	20 W	3000 K	2080 lm	SM1254	577,06 €	
					2700 K–5000 K TW	2100 lm	SM1504	622,86 €	
	schwarz, satinée/satinée black, satinée/satinée	LED	TRIAC	20 W	2700 K	2050 lm	SM1705	577,06 €	
					3000 K	2080 lm	SM1805	577,06 €	
					2700 K	2050 lm	SM1353	577,06 €	
			DALI	20 W	3000 K	2080 lm	SM1255	577,06 €	
					2700 K–5000 K TW	2100 lm	SM1505	622,86 €	
	schwarz, satinée/Raster black, satinée/raster	LED	TRIAC	20 W	2700 K	2050 lm	SM1706	577,06 €	
					3000 K	2080 lm	SM1806	577,06 €	
					2700 K	2050 lm	SM1354	577,06 €	
			DALI	20 W	3000 K	2080 lm	SM1256	577,06 €	
					2700 K–5000 K TW	2100 lm	SM1506	622,86 €	
	poliert, satinée/satinée polished, satinée/satinée	LED	TRIAC	20 W	2700 K	2050 lm	SM1707	622,86 €	
					3000 K	2080 lm	SM1807	622,86 €	
					2700 K	2050 lm	SM1355	622,86 €	
			DALI	20 W	3000 K	2080 lm	SM1257	622,86 €	
					2700 K–5000 K TW	2100 lm	SM1507	677,82 €	
	poliert, satinée/Raster polished, satinée/raster	LED	TRIAC	20 W	2700 K	2050 lm	SM1708	622,86 €	
					3000 K	2080 lm	SM1808	622,86 €	
					2700 K	2050 lm	SM1356	622,86 €	
			DALI	20 W	3000 K	2080 lm	SM1258	622,86 €	
					2700 K–5000 K TW	2100 lm	SM1508	677,82 €	

SML² Wall 900

Abbildung figure	Beschreibung description	Leuchtmittel lamp	Regelung control	Leistung power	CCT	Lumen lumen	Art.-Nr. art.-no.	€ netto CH excl. VAT	€ brutto CH incl. VAT
	silber, satinée/satinée silver, satinée/satinée	LED	TRIAC	30 W	2700 K	3070 lm	SM1709	632,02 €	
					3000 K	3120 lm	SM1809	632,02 €	
			DALI	30 W	2700 K	3070 lm	SM1357	632,02 €	
					3000 K	3120 lm	SM1259	632,02 €	
					2700 K–5000 K TW	3200 lm	SM1511	705,29 €	
	silber, satinée/Raster silver, satinée/raster	LED	TRIAC	30 W	2700 K	3070 lm	SM1710	632,02 €	
					3000 K	3120 lm	SM1810	632,02 €	
			DALI	30 W	2700 K	3070 lm	SM1358	632,02 €	
					3000 K	3120 lm	SM1260	632,02 €	
					2700 K–5000 K TW	3200 lm	SM1512	705,29 €	
	weiß, satinée/satinée white, satinée/satinée	LED	TRIAC	30 W	2700 K	3070 lm	SM1711	632,02 €	
					3000 K	3120 lm	SM1811	632,02 €	
			DALI	30 W	2700 K	3070 lm	SM1359	632,02 €	
					3000 K	3120 lm	SM1261	632,02 €	
					2700 K–5000 K TW	3200 lm	SM1513	705,29 €	
	weiß, satinée/Raster white, satinée/raster	LED	TRIAC	30 W	2700 K	3070 lm	SM1712	632,02 €	
					3000 K	3120 lm	SM1812	632,02 €	
			DALI	30 W	2700 K	3070 lm	SM1360	632,02 €	
					3000 K	3120 lm	SM1262	632,02 €	
					2700 K–5000 K TW	3200 lm	SM1514	705,29 €	
	schwarz, satinée/satinée black, satinée/satinée	LED	TRIAC	30 W	2700 K	3070 lm	SM1713	632,02 €	
					3000 K	3120 lm	SM1813	632,02 €	
			DALI	30 W	2700 K	3070 lm	SM1361	632,02 €	
					3000 K	3120 lm	SM1263	632,02 €	
					2700 K–5000 K TW	3200 lm	SM1515	705,29 €	
	schwarz, satinée/Raster black, satinée/raster	LED	TRIAC	30 W	2700 K	3070 lm	SM1714	632,02 €	
					3000 K	3120 lm	SM1814	632,02 €	
			DALI	30 W	2700 K	3070 lm	SM1362	632,02 €	
					3000 K	3120 lm	SM1264	632,02 €	
					2700 K–5000 K TW	3200 lm	SM1516	705,29 €	
	poliert, satinée/satinée polished, satinée/satinée	LED	TRIAC	30 W	2700 K	3070 lm	SM1715	677,82 €	
					3000 K	3120 lm	SM1815	677,82 €	
			DALI	30 W	2700 K	3070 lm	SM1363	677,82 €	
					3000 K	3120 lm	SM1265	677,82 €	
					2700 K–5000 K TW	3200 lm	SM1517	751,09 €	
	poliert, satinée/Raster polished, satinée/raster	LED	TRIAC	30 W	2700 K	3070 lm	SM1716	677,82 €	
					3000 K	3120 lm	SM1816	677,82 €	
			DALI	30 W	2700 K	3070 lm	SM1364	677,82 €	
					3000 K	3120 lm	SM1266	677,82 €	
					2700 K–5000 K TW	3200 lm	SM1518	751,09 €	

SML² Wall 1200

Abbildung figure	Beschreibung description	Leuchtmittel lamp	Regelung control	Leistung power	CCT	Lumen lumen	Art.-Nr. art.-no.	€ netto CH excl. VAT	€ brutto CH incl. VAT
● ⊖	silber, satinée/satinée silver, satinée/satinée	LED	TRIAC	40 W	2700 K	4000 lm	SM1717	723,61 €	
					3000 K	4180 lm	SM1817	723,61 €	
					2700 K	4000 lm	SM1365	723,61 €	
			DALI	40 W	3000 K	4180 lm	SM1267	723,61 €	
					2700 K–5000 K TW	4350 lm	SM1521	833,53 €	
● ●	silber, satinée/Raster silver, satinée/raster	LED	TRIAC	40 W	2700 K	4000 lm	SM1718	723,61 €	
					3000 K	4180 lm	SM1818	723,61 €	
					2700 K	4000 lm	SM1366	723,61 €	
			DALI	40 W	3000 K	4180 lm	SM1268	723,61 €	
					2700 K–5000 K TW	4350 lm	SM1522	833,53 €	
○ ⊖	weiß, satinée/satinée white, satinée/satinée	LED	TRIAC	40 W	2700 K	4000 lm	SM1719	723,61 €	
					3000 K	4180 lm	SM1819	723,61 €	
					2700 K	4000 lm	SM1367	723,61 €	
			DALI	40 W	3000 K	4180 lm	SM1269	723,61 €	
					2700 K–5000 K TW	4350 lm	SM1523	833,53 €	
○ ●	weiß, satinée/Raster white, satinée/raster	LED	TRIAC	40 W	2700 K	4000 lm	SM1720	723,61 €	
					3000 K	4180 lm	SM1820	723,61 €	
					2700 K	4000 lm	SM1368	723,61 €	
			DALI	40 W	3000 K	4180 lm	SM1270	723,61 €	
					2700 K–5000 K TW	4350 lm	SM1524	833,53 €	
● ⊖	schwarz, satinée/satinée black, satinée/satinée	LED	TRIAC	40 W	2700 K	4000 lm	SM1721	723,61 €	
					3000 K	4180 lm	SM1821	723,61 €	
					2700 K	4000 lm	SM1369	723,61 €	
			DALI	40 W	3000 K	4180 lm	SM1271	723,61 €	
					2700 K–5000 K TW	4350 lm	SM1525	833,53 €	
● ●	schwarz, satinée/Raster black, satinée/raster	LED	TRIAC	40 W	2700 K	4000 lm	SM1722	723,61 €	
					3000 K	4180 lm	SM1822	723,61 €	
					2700 K	4000 lm	SM1370	723,61 €	
			DALI	40 W	3000 K	4180 lm	SM1272	723,61 €	
					2700 K–5000 K TW	4350 lm	SM1526	833,53 €	
● ⊖	poliert, satinée/satinée polished, satinée/satinée	LED	TRIAC	40 W	2700 K	4000 lm	SM1723	769,41 €	
					3000 K	4180 lm	SM1823	769,41 €	
					2700 K	4000 lm	SM1371	769,41 €	
			DALI	40 W	3000 K	4180 lm	SM1273	769,41 €	
					2700 K–5000 K TW	4350 lm	SM1527	879,33 €	
● ●	poliert, satinée/Raster polished, satinée/raster	LED	TRIAC	40 W	2700 K	4000 lm	SM1724	769,41 €	
					3000 K	4180 lm	SM1824	769,41 €	
					2700 K	4000 lm	SM1372	769,41 €	
			DALI	40 W	3000 K	4180 lm	SM1274	769,41 €	
					2700 K–5000 K TW	4350 lm	SM1528	879,33 €	

WALL



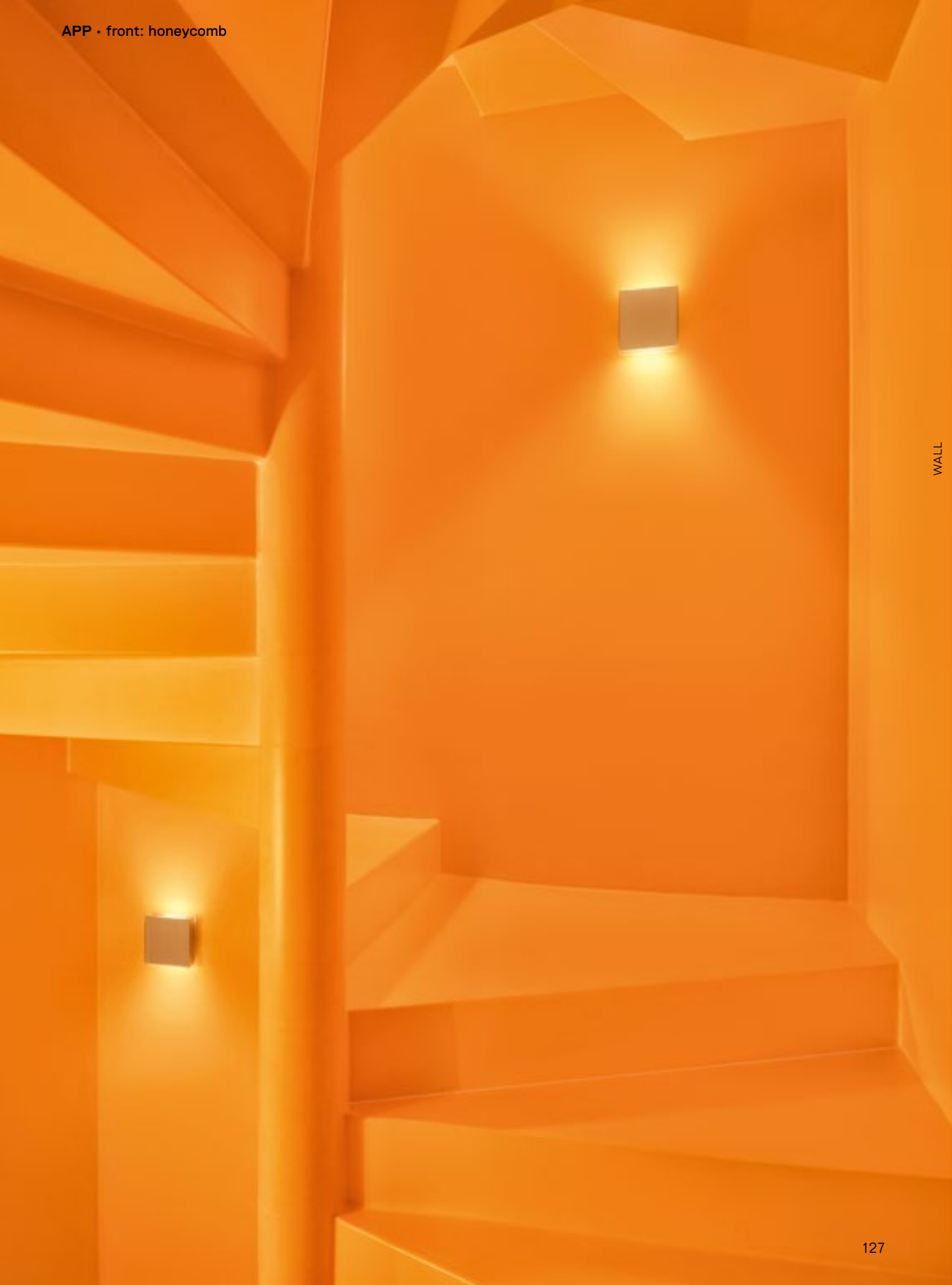



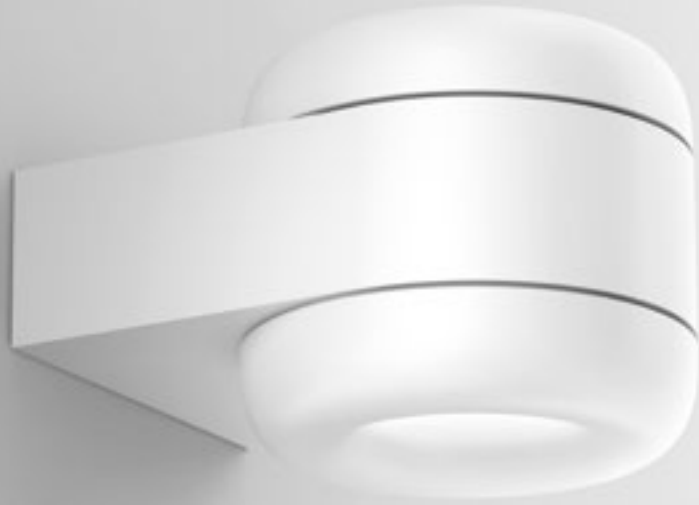





glass clear



glass new silver



acrylic glass clear





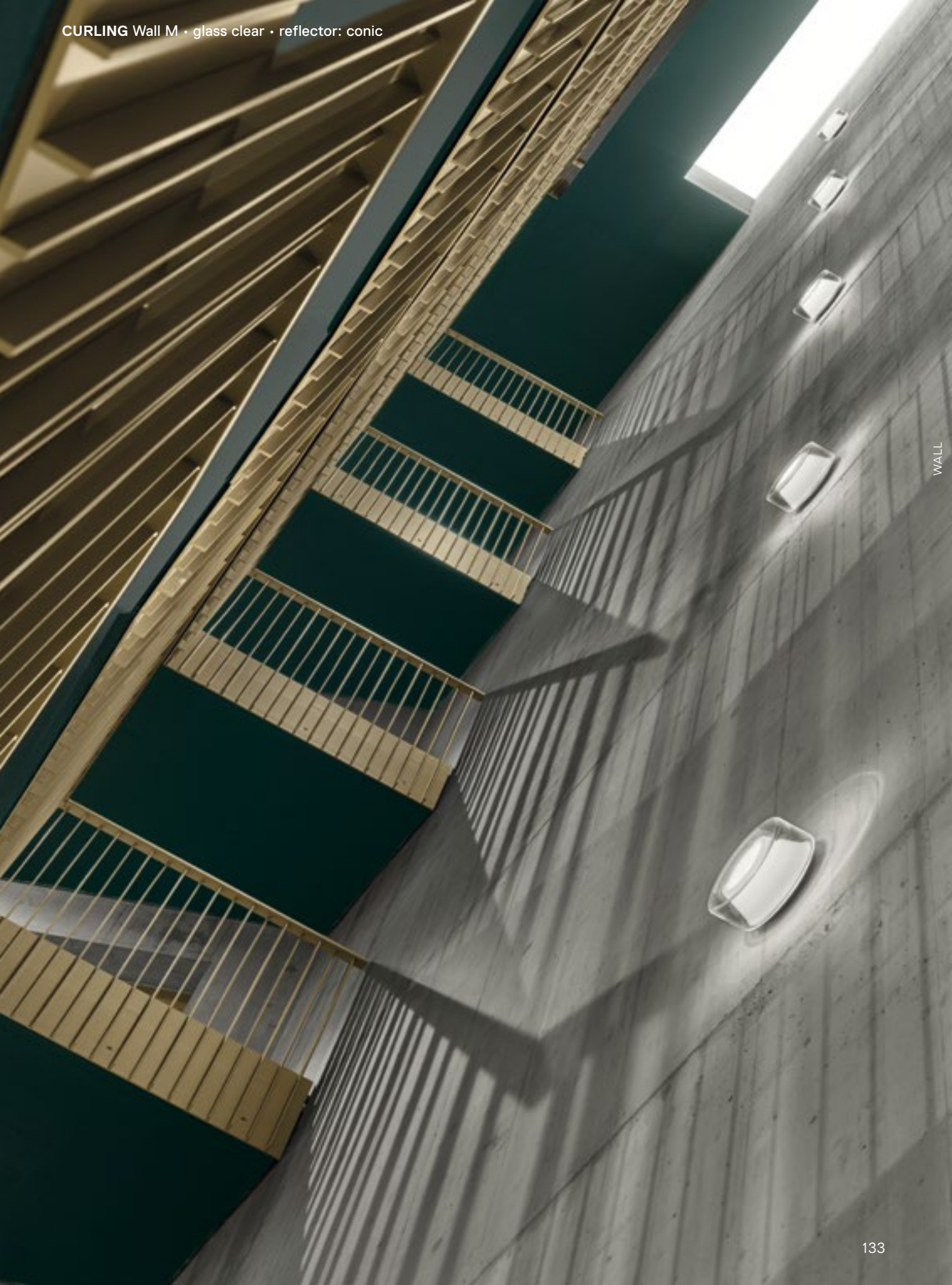





WALL







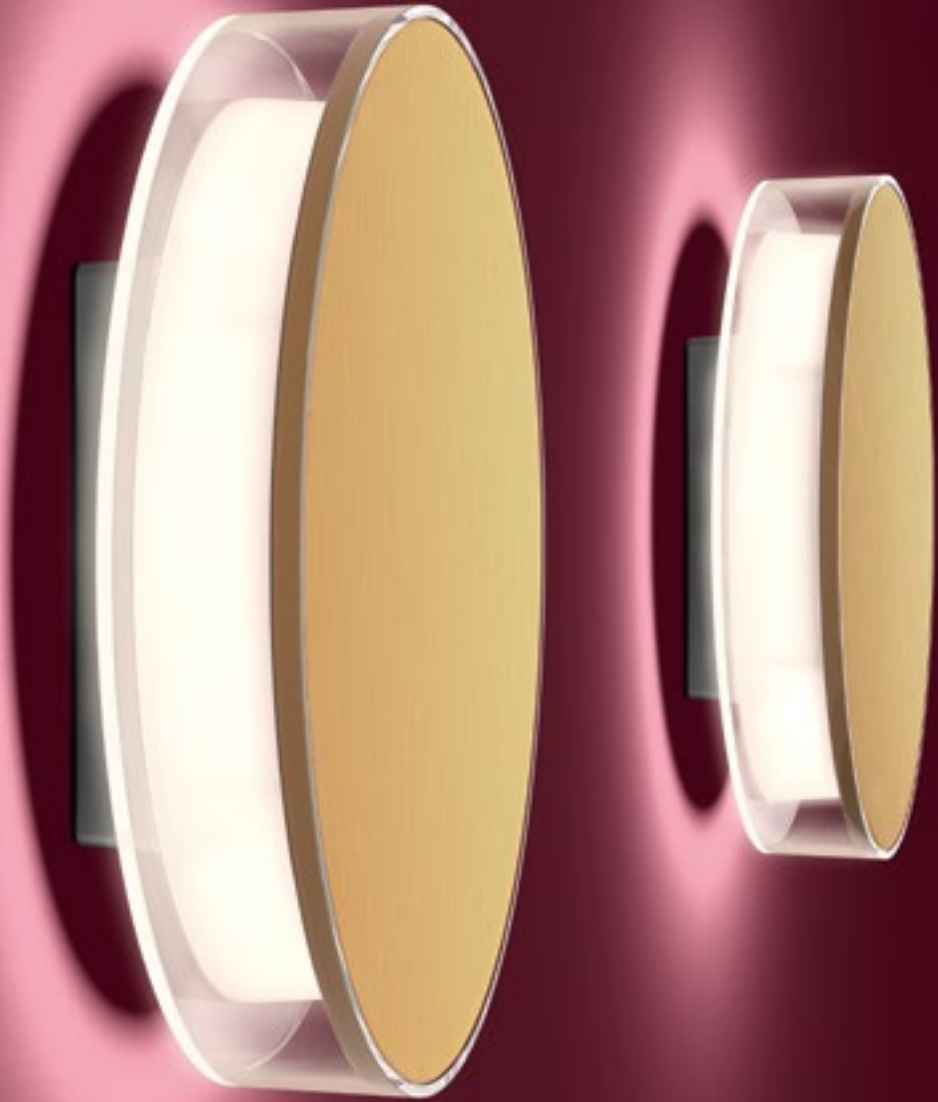

POPPY Wall • 2 arms: beige • shades: violet



3 arms: beige • shade: ceramic



3 arms: black • shade: ruby red



3 arms: black • shade: violet







REFLEX² Wall M · black



WALL

REFLEX² Wall M · white







WALL





WALL

5	• <small>Flur für Medizintechnik</small>
4	• <small>Rezeption 401 - 402</small> • <small>270 Büro (Einzel) 401-402</small> • <small>Flur für Medizintechnik</small> • <small>Flur für Spezial- und</small> • <small>Rezeptionen 401-402</small>
3	• <small>Besprechungsraum 301 - 302</small> • <small>Rezeption 301 - 302</small> • <small>Rezeption für</small> • <small>Rezeptionen 301-302</small> • <small>Rezeption für Spezial- und</small> • <small>Rezeptionen 301-302</small>
2	• <small>Besprechungsraum 201 - 202</small> • <small>Rezeption 201 - 202</small> • <small>Rezeption für</small> • <small>Rezeptionen 201-202</small> • <small>Rezeption für Spezial- und</small> • <small>Rezeptionen 201-202</small>
1	• <small>Besprechungsraum 101 - 102</small> • <small>Rezeption 101 - 102</small> • <small>Rezeption für</small> • <small>Rezeptionen 101-102</small> • <small>Rezeption für Spezial- und</small> • <small>Rezeptionen 101-102</small>
0	• <small>Rezeption 001 - 002</small> • <small>Rezeption 001 - 002</small> • <small>Rezeption für</small> • <small>Rezeptionen 001-002</small> • <small>Rezeption für Spezial- und</small> • <small>Rezeptionen 001-002</small>
-1	• <small>Flur</small> • <small>Rezeptionen 101 - 102</small> • <small>Rezeption 101 - 102</small> • <small>Rezeption 101 - 102</small> • <small>Rezeption 101 - 102</small> • <small>Rezeption 101 - 102</small>







polished

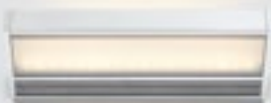

silver

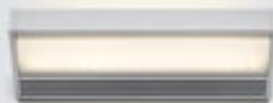

black





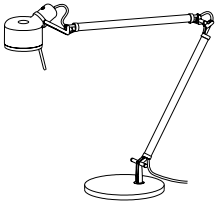

JOB
S. 155



POPPY
S. 156

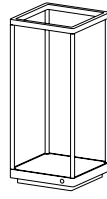

REFLEX²
S. 157

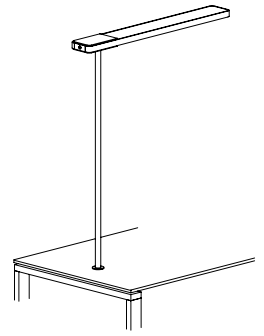

SLICE²
S. 158

JOB Table

An dieser exklusiven Variante der klassischen Schreibtischleuchte kann sich auch ein scharfes Auge lange erfreuen: alle Metallteile aus massivem, poliertem Edelstahl, Arme aus Echtglas, sorgfältigste Details (die Unterseite des Sockels ist mit Leder bezogen). JOB überzeugt auch funktional: auch bei Höchstleistung bleibt der Leuchtenkopf kühl. Dort– Wo man ihn braucht–ist auch der Schalter/Dimmer. Und Sie haben vier Befestigungen zur Wahl: Tisch-Sockel oder Tisch-Klemme, Möbeladapter für direktes Einstecken in Tischplatten oder Adapter für USM Haller-Tischsysteme.



Even a keen eye will enjoy a good long look at this exclusive version of the classic writing desk lamp: desk lamp: solid, polished stainless steel parts, genuine glass arms and great attention to details (the bottom of the base is covered with leather) JOB also stands out with regard to function: even when fully operational the head of the lamp remains cool. The switch/dimmer is also just where it is needed. And there is a choice of four mounts: Table-base or table-clamp, furniture adapter for direct fitting onto table tops or adapter for USM Haller table systems.

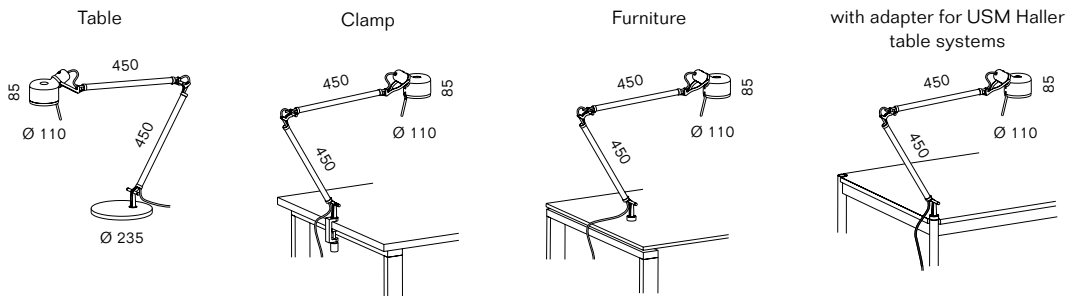

Licht light	direkt, seitlich abgeschirmt directly, laterally shielded
Leuchtmittel lamp	LED 13 W E27, CRI Ra>90 (R9>50), EEK/EEC D
Material material	Tisch-Sockel: Edelstahl poliert, unterseitig Echtleder; Tisch-Klemme und -Adapter: Edelstahl poliert Rohre: Borosilikatglas und Edelstahl poliert; Schirm: Edelstahl poliert und Borosilikatglas table base: stainless steel polished, bottom side real leather; table clamp and furniture adapter: stainless steel polished, tubes: borosilicate glass and stainless steel polished; shade: stainless steel polished and borosilicate glass
Sonstiges features	LED-Retrofit in Lieferung enthalten; An/Aus Dimmung über Taster am Leuchtenkopf LED-Retrofit included in delivery; on/off dimming via button on the head

JOB Table

Abbildung figure	Beschreibung description	Leuchtmittel lamp	Regelung control	Leistung power	CCT	Lumen lumen	Art.-Nr. art.-no.	€ netto CH excl. VAT	€ brutto CH incl. VAT
	Table	LED E27	integr.	13 W	2200–2700 K D2W	1521 lm	JB1013	1.328,15 €	
	Clamp	LED E27	integr.	13 W	2200–2700 K D2W	1521 lm	JB1014	1.117,48 €	
	Furniture	LED E27	integr.	13 W	2200–2700 K D2W	1521 lm	JB1015	1.025,88 €	
	mit Adapter für USM Haller Tischsysteme with adapter for USM Haller table systems	LED E27	integr.	13 W	2200–2700 K D2W	1521 lm	JB1016	1.025,88 €	

POPPY Table

Werden die „Mohnblüten“ dieser Familie durch Einschalten geweckt, öffnen sich ihre Schirme ganz allmählich: die feinen Blätter sind aus Bimetall und dehnen sich durch Erwärmung aus. Alle Varianten können nach Belieben umgestaltet werden. Der flexible, textilmantelte Schlauch lässt sich immer neu biegen – zur Änderung der Lichtrichtung, oder einfach weil Ihnen danach ist. Die mundgeblasenen Glaskapseln sind erhältlich in den Farben keramik, rubinrot oder violett.

When the “poppy flowers” in this family are woken by the lamp being switched on, their shades open very gradually: the delicate leaves are bi-metallic and expand when heated. All the versions can be reshaped as desired. The flexible, textile-coated stem can be bent at will, to change the direction of the light, or because you just feel like it. The hand-blown glass capsules are available in the colours ceramic, ruby red or violet.

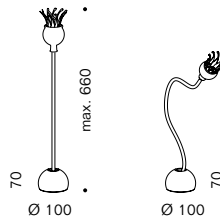

Licht light	nach vorne gerichtet, seitlich abgeschirmt directed forward, shielded to the sides
Leuchtmittel lamp	G4 35 W, 12 V, EEK/EEC G
Material material	Arme, flexibel: Aluminium, textilmantelt beige oder schwarz; Glasschirme: mundgeblasenes Glas in keramik, rubinrot oder violett; Lamellen: Bimetall; Sockel: Edelstahl, poliert arms, flexible: textile coated aluminium tube in beige or black; glass shade: hand-blown glass in ceramic, ruby red or violet; lamellae: bimetal; base: stainless steel, polished
Sonstiges features	Leuchtmittel in Lieferung enthalten; Reflektor-Lamellen öffnen sich nach ca. 2 Minuten Betriebszeit; Leuchte kann auch als Wandleuchte montiert werden lamps included in delivery; lamellae open within approx. 2 minutes after switching on luminaire; luminaire can also be mounted as wall luminaire

POPPY Table

Abbildung figure	Beschreibung description	Fassung socket	Regelung control	Leistung power	Art.-Nr. art.-no.	€ netto CH excl. VAT	€ brutto CH incl. VAT
	Arme schwarz, Schirm keramik arms black, shade ceramic	G4	ON/OFF	max. 35 W	PO1001	384,71 €	
	Arme schwarz, Schirm rubinrot arms black, shade ruby red	G4	ON/OFF	max. 35 W	PO1002	384,71 €	
	Arme schwarz, Schirm violett arms black, shade violet	G4	ON/OFF	max. 35 W	PO1003	384,71 €	
	Arme beige, Schirm keramik arms beige shade ceramic	G4	ON/OFF	max. 35 W	PO1022	384,71 €	
	Arme beige, Schirm rubinrot arms beige shade ruby red	G4	ON/OFF	max. 35 W	PO1023	384,71 €	
	Arme beige, Schirm violett arms beige shade violet	G4	ON/OFF	max. 35 W	PO1024	384,71 €	

REFLEX² Table

REFLEX² Table erweitert die Produktfamilie um eine feine, filigrane Tischleuchte. Mit ihrer offenen, graphischen Anmutung sorgt REFLEX² Table auf Tisch, Sideboard oder Boden für intensives, nach unten gerichtetes Licht. Aus einer geometrischen Rahmenstruktur entsteht so eine angenehme und atmosphärische Lichtstimmung im Raum.



REFLEX² Table extends the product family with a fine, filigree table luminaire. With its open, graphic appearance, REFLEX² Table provides intense downward light on a table, sideboard or floor, creating a pleasant and atmospheric lighting mood from a geometric frame structure.

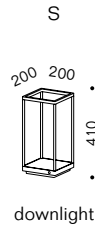

Licht light	nach unten gestreut scattered downwards
Leuchtmittel lamp	LED 33 W, CRI Ra>90 (R9>50) Dim2Warm, EEK/EEC E
Material material	Leuchtmittelabdeckungen: Flachglas satinée lamp cover: glass semigloss
Gehäuse housing	Aluminium schwarz oder weiß beschichtet aluminium black or white coated
Sonstiges features	LED austauschbar; Kabelaufwicklung unter dem Sockel; Taster für on/off/dimming im Sockel LED exchangeable; cable wrap below the base; push button for on/off/dimming in the base

REFLEX² Table S

Abbildung figure	Beschreibung description	Leuchtmittel lamp	Regelung control	Leistung power	CCT	Lumen lumen	Art.-Nr. art.-no.	€ netto CH excl. VAT	€ brutto CH incl. VAT
●	schwarz black	LED	integr.	33 W	2200–3000 K D2W	3910 lm	RE3851	531,26 €	
○	weiß white	LED	integr.	33 W	2200–3000 K D2W	3910 lm	RE3852	531,26 €	

SLICE² Furniture

Der komplett geschlossene Leuchtenkopf von SLICE² sorgt mit einer besonders innovativen Anordnung der Leuchtmittel auf zwei Ebenen für eine optimale Lichtwirkung: Breit nach oben abstrahlende LED-Streifen bieten indirektes, auch bei voller Leistung absolut blendfreies Licht. Nach unten sorgen LED-Leuchtmittel, deren Licht über die Glaskanten eingespeist und von einer prismatischen Scheibe verteilt wird, für ideales, direktes Licht auf der Arbeitsfläche.

The completely closed luminaire head of SLICE² with its particularly innovative arrangement of illuminants on two levels creates an optimum light effect: Wide-angled upwards-facing LED strips provide indirect light that is entirely glare-free even at full power. Downwards, LEDs whose light is supplied via the glass edges and distributed by a prismatic disk generate ideal direct lighting for work surfaces.

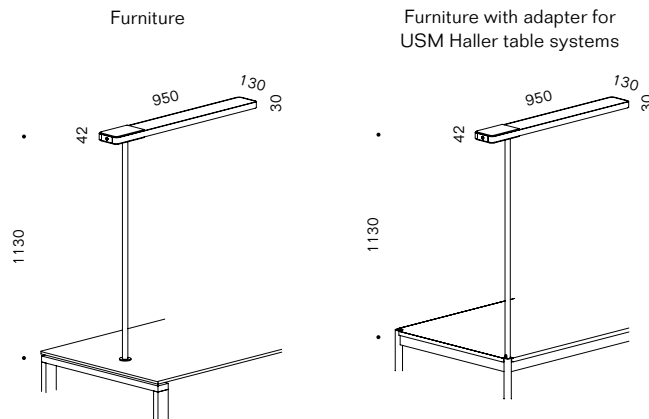

Licht light	direkt nach oben abstrahlend durch Diffusorplatte, nach unten abgeblendet durch Prismenstrukturglas; vereinheitlichte Blendungsbewertung UGR<15, Lichtverteilung: indirekt 85%, direkt 15% beaming upwards through diffuser plate, downwards directed through prism pattern glass; unified glare rating UGR<15, light distribution LED: indirect 85%, direct 15%
Leuchtmittel lamp	LED 2 × 41 W, CRI Ra>80, EEK/EEC C
Material material	Leuchtenkopf und Leuchtenrohr: glanzverchromt, schwarz, weiß oder silber beschichtet; Leuchtmittelabdeckung: unten Prismenstruktur-Acrylglas, oben Acrylglas Diffusor lamp head and tube: chrome-plated, black, white or silver coated; lamp cover: bottom prism pattern acrylic glass, top diffuser acrylic glass
Sonstiges features	LED austauschbar; vereinheitlichte Blendungsbewertung UGR<15; weitere Ausführungen (CCT/CRI/Leistung) möglich LED exchangeable; unified glare rating UGR<15; other technical versions (CCT/CRI/power) on request

SLICE² Furniture

Abbildung figure	Beschreibung description	Leuchtmittel lamp	Regelung control	Leistung power	CCT	Lumen lumen	Art.-Nr. art.-no.	€ netto CH excl. VAT	€ brutto CH incl. VAT
●	glanzverchromt chrome plated	LED	integr.	82 W	3000 K	12710 lm	SL4003	1.456,39 €	
					4000 K	13345 lm	SL4004	1.456,39 €	
			Sensorik	82 W	3000 K	12710 lm	SL5003	1.639,58 €	
					4000 K	13345 lm	SL5004	1.639,58 €	
●	schwarz black	LED	integr.	82 W	3000 K	12710 lm	SL4103	1.364,79 €	
					4000 K	13345 lm	SL4104	1.364,79 €	
			Sensorik	82 W	3000 K	12710 lm	SL5103	1.547,98 €	
					4000 K	13345 lm	SL5104	1.547,98 €	
○	weiß white	LED	integr.	82 W	3000 K	12710 lm	SL4203	1.364,79 €	
					4000 K	13345 lm	SL4204	1.364,79 €	
			Sensorik	82 W	3000 K	12710 lm	SL5203	1.547,98 €	
					4000 K	13345 lm	SL5204	1.547,98 €	
●	silber silver	LED	integr.	82 W	3000 K	12710 lm	SL4303	1.364,79 €	
					4000 K	13345 lm	SL4304	1.364,79 €	
			Sensorik	82 W	3000 K	12710 lm	SL5303	1.547,98 €	
					4000 K	13345 lm	SL5304	1.547,98 €	

SLICE² Furniture with adapter for USM Haller table systems

Abbildung figure	Beschreibung description	Leuchtmittel lamp	Regelung control	Leistung power	CCT	Lumen lumen	Art.-Nr. art.-no.	€ netto CH excl. VAT	€ brutto CH incl. VAT
●	glanzverchromt chrome plated	LED	integr.	82 W	3000 K	12710 lm	SL4013	1.456,39 €	
					4000 K	13345 lm	SL4014	1.456,39 €	
			Sensorik	82 W	3000 K	12710 lm	SL5013	1.639,58 €	
					4000 K	13345 lm	SL5014	1.639,58 €	
●	schwarz black	LED	integr.	82 W	3000 K	12710 lm	SL4113	1.364,79 €	
					4000 K	13345 lm	SL4114	1.364,79 €	
			Sensorik	82 W	3000 K	12710 lm	SL5113	1.547,98 €	
					4000 K	13345 lm	SL5114	1.547,98 €	
○	weiß white	LED	integr.	82 W	3000 K	12710 lm	SL4213	1.364,79 €	
					4000 K	13345 lm	SL4214	1.364,79 €	
			Sensorik	82 W	3000 K	12710 lm	SL5213	1.547,98 €	
					4000 K	13345 lm	SL5214	1.547,98 €	
●	silber silver	LED	integr.	82 W	3000 K	12710 lm	SL4313	1.364,79 €	
					4000 K	13345 lm	SL4314	1.364,79 €	
			Sensorik	82 W	3000 K	12710 lm	SL5313	1.547,98 €	
					4000 K	13345 lm	SL5314	1.547,98 €	





TABLE



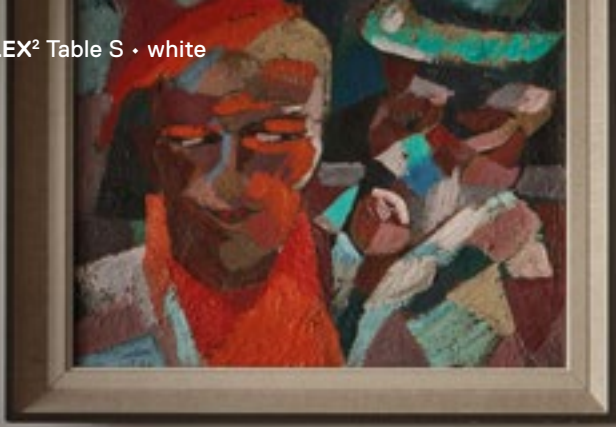





TABLE



CLUB
S. 169



JONES
S. 171



POPPY
S. 172

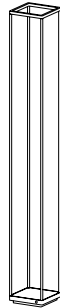

REFLEX²
S. 174

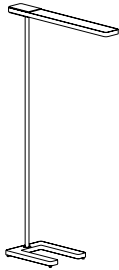

SLICE²
S. 176

CLUB Floor

Diese Familie zeitlos klassischer Schirmleuchten ist für den anspruchsvollen Bedarf optimiert. Statt eines Drahtgestells halten schlanke Aluminiumprofile die nahtlosen Schirmhälften – und vermeiden unschöne Schattenkanten. An den seitlichen Knöpfen ist ihr freundlich-atmosphärisches Licht im oberen und unteren Bereich getrennt zu regeln. Und überflüssiges Kabel wird im Fuß aufgewickelt.

This family of timelessly classical lamps with shades has been improved to satisfy sophisticated demands. Instead of a wire frame, slender aluminum profiles hold the seamless halves of the shade, avoiding unsightly shadow lines. Its friendly, atmospheric light can be regulated separately on the upper and lower section by means of the control knobs on the side. And any superfluous cable is wound up in the light unit.

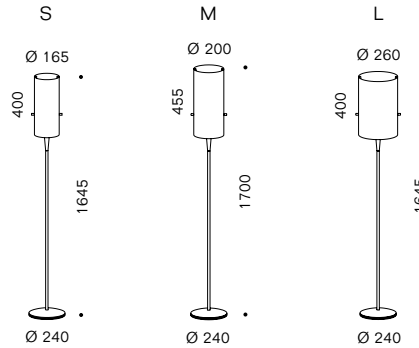

Licht
light **nach oben und unten direkt, gerichtet, diffus durch Schirm**
directly up- and downwards, directional, diffuse through shade

Leuchtmittel
lamp LED up 1 x 10 W CoB, down 2 x 5 W CoB, CRI Ra>97 (R9>93) EEK/EEC F

Material
material **Aluminium gebürstet oder schwarz lackiert; Schirm: Chintz weiß oder Melange grau**
aluminium brushed or black laquered; shade: chintz white or melange grey







Sonstiges
features **LED austauschbar; über Tastknöpfe am Schirm getrennt regelbar (on/off/dimmen)**
LED exchangeable; controlled separately (on/off/dimming) via push buttons on the shade





CLUB Floor S

Abbildung figure	Beschreibung description	Leuchtmittel lamp	Regelung control	Leistung power	CCT	Lumen lumen	Art.-Nr. art.-no.	€ netto CH excl. VAT	€ brutto CH incl. VAT
	gebürstet, Chintz weiß brushed, Chintz white	LED	integr.	20 W	2700 K	1930 lm	CL2101	879,33 €	
	schwarz, Chintz weiß black, Chintz white	LED	integr.	20 W	2700 K	1930 lm	CL2102	879,33 €	
	gebürstet, Melange grau brushed, Melange grey	LED	integr.	20 W	2700 K	1930 lm	CL2103	879,33 €	
	schwarz, Melange grau black, Melange grey	LED	integr.	20 W	2700 K	1930 lm	CL2104	879,33 €	

CLUB Floor M

Abbildung figure	Beschreibung description	Leuchtmittel lamp	Regelung control	Leistung power	CCT	Lumen lumen	Art.-Nr. art.-no.	€ netto CH excl. VAT	€ brutto CH incl. VAT
	gebürstet, Chintz weiß brushed, Chintz white	LED	integr.	20 W	2700 K	1930 lm	CL2111	879,33 €	
	schwarz, Chintz weiß black, Chintz white	LED	integr.	20 W	2700 K	1930 lm	CL2112	879,33 €	
	gebürstet, Melange grau brushed, Melange grey	LED	integr.	20 W	2700 K	1930 lm	CL2113	879,33 €	
	schwarz, Melange grau black, Melange grey	LED	integr.	20 W	2700 K	1930 lm	CL2114	879,33 €	

CLUB Floor L

Abbildung figure	Beschreibung description	Leuchtmittel lamp	Regelung control	Leistung power	CCT	Lumen lumen	Art.-Nr. art.-no.	€ netto CH excl. VAT	€ brutto CH incl. VAT
	gebürstet, Chintz weiß brushed, Chintz white	LED	integr.	20 W	2700 K	1930 lm	CL2121	879,33 €	
	schwarz, Chintz weiß black, Chintz white	LED	integr.	20 W	2700 K	1930 lm	CL2122	879,33 €	
	gebürstet, Melange grau brushed, Melange grey	LED	integr.	20 W	2700 K	1930 lm	CL2123	879,33 €	
	schwarz, Melange grau black, Melange grey	LED	integr.	20 W	2700 K	1930 lm	CL2124	879,33 €	

JONES Floor

Diese diskrete Dame wird auf den ersten Blick gern unterschätzt. JONES ist kräftiger Deckenfluter, intime Leseleuchte und atmosphärische Schirmleuchte in einer Gestalt. Ihre Verwandlung funktioniert ganz einfach über zwei Knöpfe am Standrohr der Leuchte, ein dritter regelt die Helligkeit. Und mit dem farbigen Glaseinsatz leuchtet der weiße Schirm –erhältlich in zwei Größen–auf Wunsch farbig.



At first sight this discreet lady is often underestimated. JONES is a powerful uplight, intimate reading light and atmospheric shade lamp in one. It is transformed extremely easily by means of two buttons on the lamp' upright tube, while a third regulates the brightness. And if desired, a coloured glass insert causes the white shade, which is available in two sizes, to shine in colour.

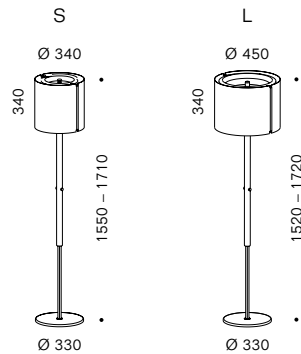

Licht light	stufenlos einstellbar: Leselicht, gerichtet nach unten. Dekoratives Licht, gerichtet nach unten und oben, rundum diffus durch Schirm (farbig durch Glaseinsatz) Indirektes Licht, gerichtet nach oben Infinitely adjustable: reading light, directed downwards. Decorative light, directed downwards and upwards, diffused all around by shade (coloured by glass insert). Indirect light, directed upwards.
Leuchtmittel lamp	LED 38 W CoB, CRI Ra>97 (R9>90), EEK/EEC F E27 max. 205 W, EEK/EEC G (Lieferung ohne Leuchtmittel/delivery without bulb)
Material material	Schirm: Glashartgewebe textilkaschiert weiß. Rundrohr und Sockel: Aluminium gebürstet und schutzlackiert oder schwarz lackiert Vierkantrrohr: Aluminium verchromt. Glaseinsatz: Borosilikatglas orange shade: glass fabric laminated, white; round rod and base: aluminum brushed with protective coating or laquered black square rod: aluminum chrome-plated; colored glass insert: borosilicate glass orange
Sonstiges features	LED austauschbar; farbiger Glaseinsatz leicht und schnell einsetzbar; Taster für on/off/dimming im Standrohr LED exchangeable; colored glass insert easily replaceable; push buttons für on/off/dimming in the standpipe

JONES Floor S

Abbildung figure	Beschreibung description	Leuchtmittel lamp	Regelung control	Leistung power	CCT	Lumen lumen	Art.-Nr. art.-no.	€ netto CH excl. VAT	€ brutto CH incl. VAT
●	gebürstet brushed	LED	integr.	38 W	2700 K	3500 lm	JO3016	1.822,77 €	
		E27	integr.	max. 205 W	3000 K	4200 lm	JO1010	1.364,79 €	
●	schwarz black	LED	integr.	38 W	2700 K	3500 lm	JO3117	1.822,77 €	

JONES Floor L

Abbildung figure	Beschreibung description	Leuchtmittel lamp	Regelung control	Leistung power	CCT	Lumen lumen	Art.-Nr. art.-no.	€ netto CH excl. VAT	€ brutto CH incl. VAT
●	gebürstet brushed	LED	integr.	38 W	2700 K	3500 lm	JO3015	1.822,77 €	
		E27	integr.	max. 205 W	3000 K	4200 lm	JO1007	1.364,79 €	
●	schwarz black	LED	integr.	38 W	2700 K	3500 lm	JO3115	1.822,77 €	

POPPY Floor

Werden die „Mohnblüten“ dieser Familie durch Einschalten geweckt, öffnen sich ihre Schirme ganz allmählich: die feinen Blätter sind aus Bimetall und dehnen sich durch Erwärmung aus. Alle Varianten können nach Belieben umgestaltet werden. Der flexible, textilmantelte Schlauch lässt sich immer neu biegen – zur Änderung der Lichtrichtung, oder einfach weil Ihnen danach ist. Die mundgeblasenen Glaskapseln sind erhältlich in den Farben keramik, rubinrot oder violett.

When the “poppy flowers” in this family are woken by the lamp being switched on, their shades open very gradually: the delicate leaves are bi-metallic and expand when heated. All the versions can be reshaped as desired. The flexible, textile-coated stem can be bent at will, to change the direction of the light, or because you just feel like it. The hand-blown glass capsules are available in the colours ceramic, ruby red or violet.

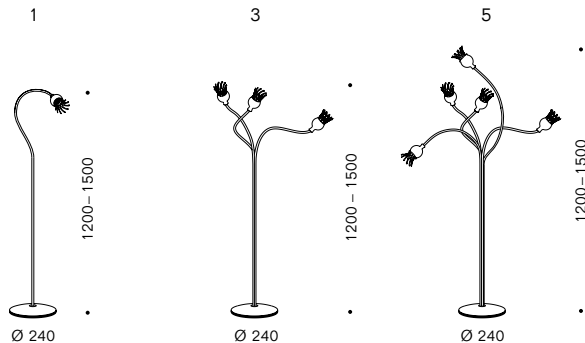

Licht
light **nach vorne gerichtet, seitlich abgeschirmt**
directed forward, shielded to the sides

Leuchtmittel
lamp **POPPY Floor 1/3: 1 x/3 x G4 35 W, 12 V, EEK/EEC G**
POPPY Floor 5: 5 x G4 20 W, 12 V, EEK/EEC G







Material
material **Arme, flexibel: Aluminium, textilmantelt beige oder schwarz;**
Glasschirme: mundgeblasenes Glas keramik, rubinrot oder violett; Lamellen: Bimetall; Sockel: Stahl
arms: flexible, textile coated aluminium tube in beige or black; glass shade: hand-blown glass in ceramic, ruby red or violet; lamellae: bimetal; base: steel

Sonstiges
features **Leuchtmittel in Lieferung enthalten; Reflektor-Lamellen öffnen sich nach ca. 2 Minuten Betriebszeit**
lamps included in delivery; lamellae open within approx. 2 minutes after switching on luminaire







POPPY Floor 1

Abbildung figure	Beschreibung description	Fassung lamp	Regelung control	Leistung power	Art.-Nr. art.-no.	€ netto CH excl. VAT	€ brutto CH incl. VAT
	1 Arm schwarz, Schirm keramik 1 arm black, shade ceramic	G4	ON/OFF	35 W	PO1052	540,42 €	
	1 Arm schwarz, Schirm rubinrot 1 arm black, shade red	G4	ON/OFF	35 W	PO1051	540,42 €	
	1 Arm schwarz, Schirm violett 1 arm black, shade violet	G4	ON/OFF	35 W	PO1050	540,42 €	
	1 Arm beige, Schirm keramik 1 arm beige shade ceramic	G4	ON/OFF	35 W	PO1055	540,42 €	
	1 Arm beige, Schirm rubinrot 1 arm beige shade red	G4	ON/OFF	35 W	PO1054	540,42 €	
	1 Arm beige, Schirm violett 1 arm beige shade violet	G4	ON/OFF	35 W	PO1053	540,42 €	

POPPY Floor 3

Abbildung figure	Beschreibung description	Fassung lamp	Regelung control	Leistung power	Art.-Nr. art.-no.	€ netto CH excl. VAT	€ brutto CH incl. VAT
	3 Arme schwarz, Schirme keramik 3 arms black, shades ceramic	3 × G4	ON/OFF	105 W	PO1058	751,09 €	
	3 Arme schwarz, Schirme rubinrot 3 arms black, shades red	3 × G4	ON/OFF	105 W	PO1057	751,09 €	
	3 Arme schwarz, Schirme violett 3 arms black, shades violet	3 × G4	ON/OFF	105 W	PO1056	751,09 €	
	3 Arme beige, Schirme keramik 3 arms beige shades ceramic	3 × G4	ON/OFF	105 W	PO1061	751,09 €	
	3 Arme beige, Schirme rubinrot 3 arms beige shades red	3 × G4	ON/OFF	105 W	PO1060	751,09 €	
	3 Arme beige, Schirme violett 3 arms beige shades violet	3 × G4	ON/OFF	105 W	PO1059	751,09 €	

POPPY Floor 5

Abbildung figure	Beschreibung description	Fassung lamp	Regelung control	Leistung power	Art.-Nr. art.-no.	€ netto CH excl. VAT	€ brutto CH incl. VAT
	5 Arme schwarz, Schirme keramik 5 arms black, shades ceramic	5 × G4	ON/OFF	100 W	PO1064	952,61 €	
	5 Arme schwarz, Schirme rubinrot 5 arms black, shades red	5 × G4	ON/OFF	100 W	PO1063	952,61 €	
	5 Arme schwarz, Schirme violett 5 arms black, shades violet	5 × G4	ON/OFF	100 W	PO1062	952,61 €	
	5 Arme beige, Schirme keramik 5 arms beige shades ceramic	5 × G4	ON/OFF	100 W	PO1067	952,61 €	
	5 Arme beige, Schirme rubinrot 5 arms beige shades red	5 × G4	ON/OFF	100 W	PO1066	952,61 €	
	5 Arme beige, Schirme violett 5 arms beige shades violet	5 × G4	ON/OFF	100 W	PO1065	952,61 €	

REFLEX² Floor

Die Stehleuchten der REFLEX²-Produktfamilie scheinen mit Ihren schwarzen oder weißen Linien lediglich die Konturen eines Quaders nachzuzeichnen. Alle Modelle besitzen eine feine, elegant abgerundete Rahmenstruktur, in der sich die LED-Platinen befinden. Die Deckenfluter strahlen absolut blendfreies Licht über die Decke in den Raum, wohingegen die Leseleuchte sanft, aber intensiv nach unten leuchtet. Aus einer dezenten Struktur entsteht so eine intensive Lichtstimmung. Gesteuert wird das Licht über Taster im Sockel, die beim Modell M zusätzlich zur Helligkeit auch die Lichtfarbe regeln.

The floor luminaires of the REFLEX² family with their black or white lines seem to merely trace the contours of a cuboid. All models have a fine, elegantly rounded framework structure, which contains the LED circuit boards. The ceiling washlights radiate absolutely glare-free light into the room via the ceiling, whereas the reading luminaire provides a soft but intense downward light. A subtle structure that creates an intense lighting atmosphere in the room. The light is controlled via push-buttons in the base, which in the case of the M model not only regulate brightness but also light color.

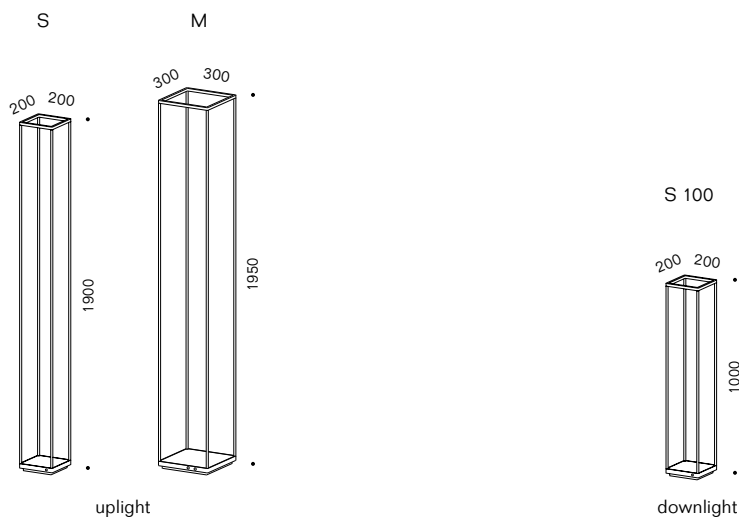

Licht light	nach oben gestreut, indirekt über Decke scattered upwards, diffuse all around via ceiling	nach unten gestreut scattered downwards
Leuchtmittel lamp	LED 35–50 W, CRI Ra>90 (R9>50); S: Dim2Warm, M: 2200–4000 K/tunable white; EEK/EEC E	LED 33 W, CRI Ra>90 (R9>50) Dim2Warm, EEK/EEC E
Material material	Leuchtmittelabdeckungen: Flachglas satinée lamp cover: glass semigloss	
Gehäuse housing	Aluminium schwarz oder weiß beschichtet aluminium black or white coated	
Sonstiges features	LED austauschbar; Kabelaufwicklung unter dem Sockel; Fusstaster für on/off/dimming (S, M) und Colour dimming (M) im Sockel LED exchangeable; Cable wrap below base; push buttons for on/off/dimming (S, M) and colour dimming (M) in the base	



Focus Open 2022
Special Mention

REFLEX² Floor S

Abbildung figure	Beschreibung description	Leuchtmittel lamp	Regelung control	Leistung power	CCT	Lumen lumen	Art.-Nr. art.-no.	€ netto CH excl. VAT	€ brutto CH incl. VAT
●	schwarz black	LED	integr.	33 W	2200–3000 K D2W	3910 lm	RE3551	897,65 €	
○	weiß white	LED	integr.	33 W	2200–3000 K D2W	3910 lm	RE3552	897,65 €	

REFLEX² Floor M

Abbildung figure	Beschreibung description	Leuchtmittel lamp	Regelung control	Leistung power	CCT	Lumen lumen	Art.-Nr. art.-no.	€ netto CH excl. VAT	€ brutto CH incl. VAT
●	schwarz black	LED	integr.	50 W	2200–4000 K TW	6040 lm	RE3653	1.154,12 €	
○	weiß white	LED	integr.	50 W	2200–4000 K TW	6040 lm	RE3654	1.154,12 €	

REFLEX² Floor S 100 new

Abbildung figure	Beschreibung description	Leuchtmittel lamp	Regelung control	Leistung power	CCT	Lumen lumen	Art.-Nr. art.-no.	€ netto CH excl. VAT	€ brutto CH incl. VAT
●	schwarz black	LED	integr.	33 W	2200–3000 K D2W	3910 lm	RE3751	622,86 €	
○	weiß white	LED	integr.	33 W	2200–3000 K D2W	3910 lm	RE3752	622,86 €	

SLICE² Floor

SLICE² entwickelt die erfolgreiche SLICE technisch, funktional und formalästhetisch weiter. Der komplett geschlossene Leuchtenkopf sorgt mit einer besonders innovativen Anordnung der Leuchtmittel auf zwei Ebenen für eine optimale Lichtwirkung: Breit nach oben abstrahlende LED-Streifen bieten indirektes, auch bei voller Leistung absolut blendfreies Licht. Nach unten sorgen LED-Leuchtmittel, deren Licht über die Glaskanten eingespeist und von einer prismatischen Scheibe verteilt wird, für ideales, direktes Licht auf der Arbeitsfläche.

SLICE² further develops the successful SLICE with a view to technology, functionality and formal aesthetics. The completely closed luminaire head with its particularly innovative arrangement of illuminants on two levels creates an optimum light effect: Wide-angled upwards-facing LED strips provide indirect light that is entirely glare-free even at full power. Downwards, LEDs whose light is supplied via the glass edges and distributed by a prismatic disk generate ideal direct lighting for work surfaces.

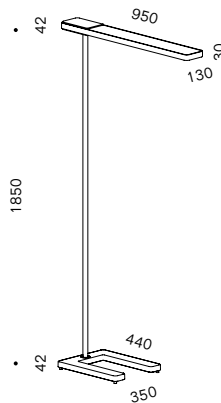

Licht light	direkt nach oben abstrahlend durch Diffusorplatte, nach unten abgeblendet durch Prismenstrukturglas; vereinheitlichte Blendungsbewertung UGR<15, Lichtverteilung: indirekt 85%, direkt 15% beaming upwards through diffuser plate, downwards directed through prism pattern glass; unified glare rating UGR<15, light distribution: indirect 85%, direct 15%
Leuchtmittel lamp	LED 2×41 W, CRI Ra>80, EEK/EEC C
Material material	Leuchtenkopf, Leuchtenrohr und Sockel: Aluminium glanzverchromt (außer Sockel), schwarz, weiß oder silberbeschichtet; Leuchtmittelabdeckung: unten Prismenstruktur-Acrylglas, oben Acrylglas Diffusor lamp head, tube and light unit: aluminium chrome-plated (except base), black, white or silver coated; lamp cover: down prism pattern acrylic glass, top diffuser acrylic glass
Sonstiges features	LED austauschbar; weitere Ausführungen (CCT/CRI/Leistung) möglich LED exchangeable; other technical versions (CCT/CRI/power) on request

SLICE² Floor

Abbildung figure	Beschreibung description	Leuchtmittel lamp	Regelung control	Leistung power	CCT	Lumen lumen	Art.-Nr. art.-no.	€ netto CH excl. VAT	€ brutto CH incl. VAT
●	glanzverchromt, Sockel silber chrome plated, base silver	LED	integr.	82 W	3000 K	12570 lm	SL2003	1.639,58 €	
					4000 K	13320 lm	SL2004	1.639,58 €	
●	schwarz black	LED	integr.	82 W	3000 K	12570 lm	SL2103	1.547,98 €	
					4000 K	13320 lm	SL2104	1.547,98 €	
○	weiß white	LED	integr.	82 W	3000 K	12570 lm	SL2203	1.547,98 €	
					4000 K	13320 lm	SL2204	1.547,98 €	
●	silber silver	LED	integr.	82 W	3000 K	12570 lm	SL2303	1.547,98 €	
					4000 K	13320 lm	SL2304	1.547,98 €	

SLICE² Floor Sensorik

Abbildung figure	Beschreibung description	Leuchtmittel lamp	Regelung control	Leistung power	CCT	Lumen lumen	Art.-Nr. art.-no.	€ netto CH excl. VAT	€ brutto CH incl. VAT
●	glanzverchromt, Sockel silber chrome plated, base silver	LED	Sensorik	82 W	3000 K	12570 lm	SL3003	1.822,77 €	
					4000 K	13320 lm	SL3004	1.822,77 €	
●	schwarz black	LED	Sensorik	82 W	3000 K	12570 lm	SL3103	1.731,18 €	
					4000 K	13320 lm	SL3104	1.731,18 €	
○	weiß white	LED	Sensorik	82 W	3000 K	12570 lm	SL3203	1.731,18 €	
					4000 K	13320 lm	SL3204	1.731,18 €	
●	silber silver	LED	Sensorik	82 W	3000 K	12570 lm	SL3303	1.731,18 €	
					4000 K	13320 lm	SL3304	1.731,18 €	





FLOOR





FLOOR





FLOOR



THE
SUN
IS
GONE
BUT
WE
HAVE
THE
LIGHT







FLOOR







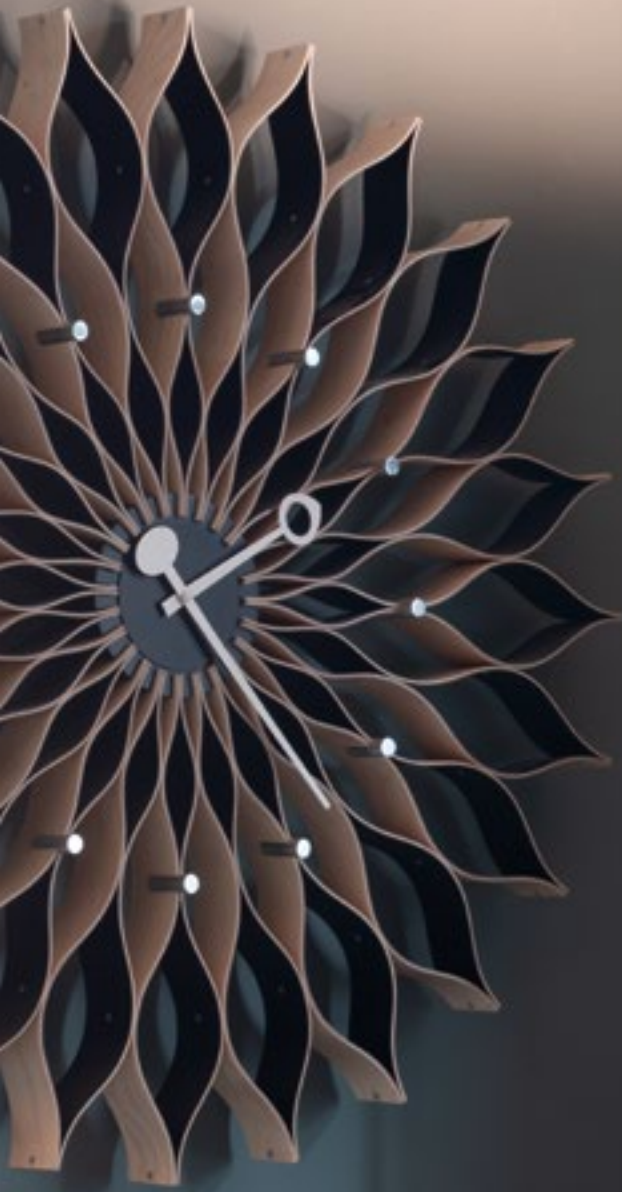









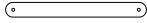

BALDACHINPROFIL 2
CANOPY PROFILE 2
S. 198

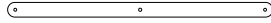

BALDACHINPROFIL 3
CANOPY PROFILE 3
S. 199

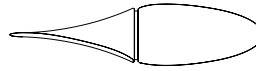

ERSATZBEZUG
REPLACEMENT COVER
S. 200



KRISTALLGLAS ANHÄNGER
CRYSTAL GLAS PENDANT
S. 200



OPTIKEN
OPTICS
S. 201



SPIEGEL ADAPTER SET
MIRROR ADAPTER SET
S. 201



WANDADAPTER
WALL COVER
S. 202

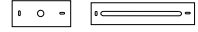

WANDABDECKUNGEN
WALL COVER
S. 203

BALDACHINPROFIL 2 / CANOPY PROFILE 2

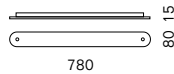

Material Aluminium gebürstet oder poliert, schwarz oder weiß lackiert
material aluminium brushed or polished, black or white coated

Passend für CAVITY Suspension L; CURLING Suspension Rope/Tube S, M, L;
Suitable for DRAFT Suspension Rope/Tube S, M; DRUM Suspension Rope/Tube S, M; REEF Suspension 1

Abbildung figure	Beschreibung description	Art.-Nr. art.-no.	€ netto CH excl. VAT	€ brutto CH incl. VAT
●	gebürstet brushed	BP1001	293,11 €	
●	poliert polished	BP1002	320,59 €	
●	schwarz black	BP1009	293,11 €	
○	weiß white	BP1010	293,11 €	



DRAFT Suspension Rope M

Maße measurements

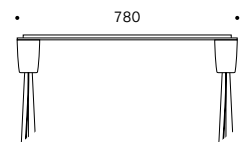

CAVITY Suspension L

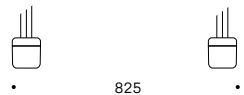

CURLING Suspension Rope M

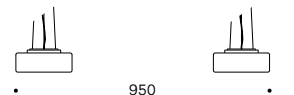

DRAFT Suspension Rope M

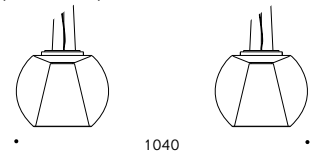

DRUM Suspension Rope M long

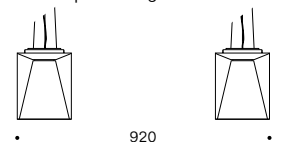

DRUM Suspension Tube M short

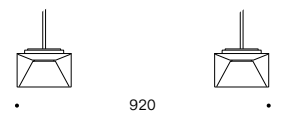

REEF Suspension 1



BALDACHINPROFIL 3 / CANOPY PROFILE 3

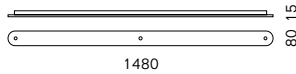

Material Aluminium gebürstet oder poliert, schwarz oder weiß lackiert
material aluminium brushed or polished, black or white coated

Passend für CAVITY Suspension L; CURLING Suspension Rope/Tube S, M, L;
Suitable for DRAFT Suspension Rope/Tube S, M; DRUM Suspension Rope/Tube S, M; REEF Suspension 1

Abbildung figure	Beschreibung description	Art.-Nr. art.-no.	€ netto CH excl. VAT	€ brutto CH incl. VAT
	gebürstet brushed	BP1004	375,55 €	
	poliert polished	BP1005	412,18 €	
	schwarz black	BP1013	375,55 €	
	weiß white	BP1014	375,55 €	

Maße
measurement

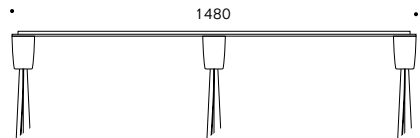

CAVITY Suspension L

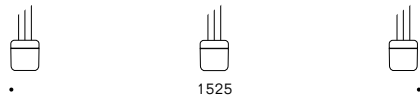

CAVITY Suspension L

CURLING Suspension Rope M

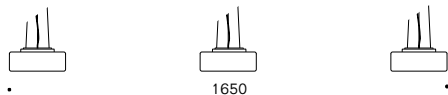

CURLING / DRAFT / DRUM
Suspension Tube / Rope M

DRAFT Suspension Rope M

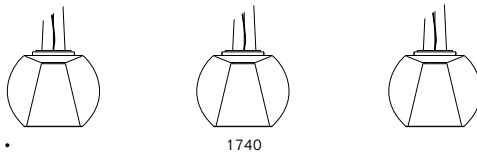

DRUM Suspension Rope M long

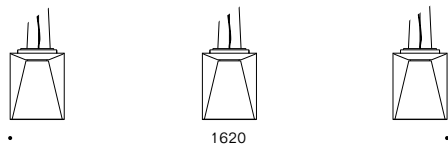

DRUM Suspension Tube M short

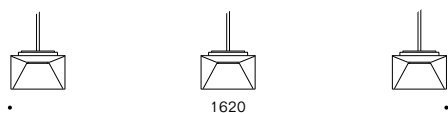

REEF Suspension 1

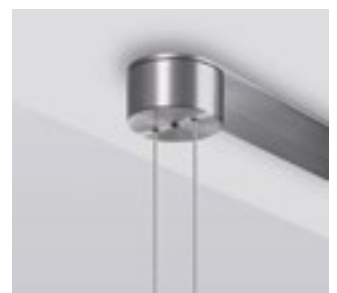
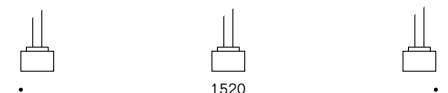

REEF Suspension

ERSATZBEZUG / REPLACEMENT COVER

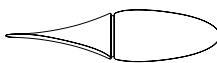

Material
material **Stoffbezug weiß aus 80% Polyamid und 20% Elasthan**
cover white made of 80% polyamide and 20% elastane

Sonstiges
features **werkzeuglose Montage über Federstahldraht**
mounting tool-free to spring steel wire

Passend für
Suitable for PROPELLER

Abbildung figure	Beschreibung description	Art.-Nr. art.-no.	€ netto CH excl. VAT	€ brutto CH incl. VAT
○	weiß white	PR1004	100,76 €	

KRISTALLGLAS ANHÄNGER / CRYSTAL GLAS PENDANT



Material
material **mehrgliedrige Anhänger: 3 Octagon-Elemente mit 1 Eiszapfen-Element aus geschliffenem Kristallglas,**
ZOOM Anhänger ca. 60 mm, ZOOM XL Anhänger ca. 100 mm
polynomial pendant: 3 octagon elements with 1 icicle made of edged crystal glass, ZOOM pendant approx.
60 mm, ZOOM XL pendant approx. 100 mm

Sonstiges
features **werkzeuglose Montage durch Einhängen in die unteren Scherengitterdrehpunkte**
simple mounting by hooking in lower snake fence's pivot points

Passend für
Suitable for ZOOM, ZOOM XL

Abbildung figure	Beschreibung description	Art.-Nr. art.-no.	€ netto CH excl. VAT	€ brutto CH incl. VAT
○	ZOOM Kristallglas Set (20 Stk.) ZOOM Kristallglas Set (20 pcs.)	ZO1014	178,61 €	
○	ZOOM XL Kristallglas Set (20 Stk.) ZOOM XL Kristallglas Set (20 pcs.)	ZO1015	361,81 €	

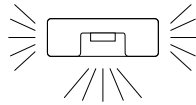

Diffusorscheibe (enthalten)
diffuser (included)

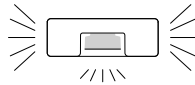

abgeblendet/deglared
CU8535

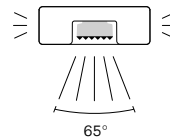

microprismatic
CU8536

Optiken
optics

Mit den einfach austauschbaren Optiken haben Sie die Möglichkeit, die Lichtverteilung der CURLING zu steuern: In Lieferung enthalten ist eine Echtglas-Streuscheibe für gleichmäßiges, weiches Direkt- und Raumlicht. Optional erhältlich sind eine Entblendungs-Optik für viel Raumlicht und starke Direktlichtentblendung oder eine Mikroprismatik-Optik für gerichtetes Direktlicht im Abstrahlwinkel von 65°.

With the easily replaceable optics, you define the light distribution of CURLING: Included in the scope of delivery is a real-glass diffuser lens for uniform, soft direct and ambient light. Optionally available is the anti-glare optic for intensive ambient light and strong but glare-free direct light or a microprismatic optic for directional direct light with a beam angle of 65°.

Passend für
Suitable for

CURLING M

Abbildung figure	Beschreibung description	Art.-Nr. art.-no.	€ netto CH excl. VAT	€ brutto CH incl. VAT
	Optik S abgeblendet Optic S deglared	CU8532	22,90 €	
	Optik S Mikroprismatik Optic S microprismatic	CU8539	27,48 €	
	Optik M abgeblendet Optic M deglared	CU8535	38,47 €	
	Optik M Mikroprismatik Optic M microprismatic	CU8536	43,97 €	
	Optik L abgeblendet Optic L deglared	CU8537	45,80 €	
	Optik L Mikroprismatik Optic L microprismatic	CU8541	52,21 €	

SPIEGEL ADAPTER SET / MIRROR ADAPTER SET



Material
material

Kunststoffgewindeeinsätze zur Montage auf Echtglasspiegel (bis 8 mm Glasstärke)
plastic thread insert for mounting on glass mirror (up to 8 mm glass thickness)

Passend für
Suitable for

APP Wall, CAVITY Wall, CRIB Wall, LID Wall, SML Wall, SML² Wall
(jeweils alle Größen bzw. Längen) / (all sizes each)

Abbildung figure	Beschreibung description	Art.-Nr. art.-no.	€ netto CH excl. VAT	€ brutto CH incl. VAT
	Set	ZB1001	41,22 €	

WALL ADAPTERS / WANDADAPTER

SML² Wall

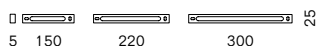

Material material	Aluminium silber, schwarz, weiß lackiert oder poliert aluminium coated silver, black, white or polished
Sonstiges features	Montagehilfe bei nicht mittigem Stromanschluss; weitere Längen auf Anfrage mounting aid for centered power connection; other lengths on request
Passend für Suitable for	SML² Wall 150, 220, 300; weitere Längen auf Anfrage SML ² Wall 150, 220, 300; other lengths on request

Abbildung figure	Beschreibung description	Art.-Nr. art.-no.	€ netto CH excl. VAT	€ brutto CH incl. VAT
●	150 silber 150 silver	SM8801	25,65 €	
○	150 weiß 150 white	SM8802	25,65 €	
●	150 schwarz 150 black	SM8803	25,65 €	
●	150 poliert 150 polished	SM8804	25,65 €	
●	220 silber 220 silver	SM8805	29,31 €	
○	220 weiß 220 white	SM8806	29,31 €	
●	220 schwarz 220 black	SM8807	29,31 €	
●	220 poliert 220 polished	SM8808	29,31 €	
●	300 silber 300 silver	SM8809	32,06 €	
○	300 weiß 300 white	SM8810	32,06 €	
●	300 schwarz 300 black	SM8811	32,06 €	
●	300 poliert 300 polished	SM8812	32,06 €	

WALL COVER / WANDABDECKUNGEN

REFLEX² Wall

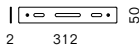

SML Wall

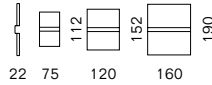

SML² Wall

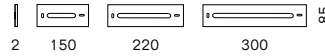

Sonstiges zur Abdeckung von z.B Anschlussdosen
features to cover e.g. junction boxes

REFLEX ² Wall				
Abbildung figure	Beschreibung description	Art.-Nr. art.-no.	€ netto CH excl. VAT	€ brutto CH incl. VAT
●	schwarz black	RE8520	32,06 €	
○	weiß white	RE8521	32,06 €	

SML Wall				
Abbildung figure	Beschreibung description	Art.-Nr. art.-no.	€ netto CH excl. VAT	€ brutto CH incl. VAT
●	S silber eloxiert S silver anodized	SM1053	33,89 €	
●	S glanzverchromt S chrome-plated	SM3053	49,46 €	
●	M silber eloxiert M silver anodized	SM1054	35,72 €	
●	M glanzverchromt M chrome-plated	SM3054	54,96 €	
●	L silber eloxiert L silver anodized	SM1055	41,22 €	
●	L glanzverchromt L chrome-plated	SM3055	59,54 €	

SML ² Wall				
Abbildung figure	Beschreibung description	Art.-Nr. art.-no.	€ netto CH excl. VAT	€ brutto CH incl. VAT
●	150 silber 150 silver	SM4053	36,64 €	
○	150 weiß 150 white	SM4056	36,64 €	
●	150 schwarz 150 black	SM4059	36,64 €	
●	150 poliert 150 polished	SM4062	36,64 €	
●	220 silber 220 silver	SM4054	41,22 €	
○	220 weiß 220 white	SM4057	41,22 €	
●	220 schwarz 220 black	SM4060	41,22 €	
●	220 poliert 220 polished	SM4052	41,22 €	
●	300 silber 300 silver	SM4055	45,80 €	
○	300 weiß 300 white	SM4058	45,80 €	
●	300 schwarz 300 black	SM4061	45,80 €	
●	300 poliert 300 polished	SM4048	45,80 €	

Information



Unsere Produkte sind so konstruiert, dass beim Austausch von Lichtquellen nur eine qualifizierte Fachkraft sicherstellen kann, dass diese nicht verunreinigt und/oder beschädigt werden. Die Lebensdauer der Lichtquellen wird durch die Montageart mit Wärmeleitpads unmittelbar beeinflusst. Daher wird der nicht fachmännische Austausch von Lichtquellen und separaten Betriebsgeräten als nicht sinnvoll angesehen.

Our products are designed in such a way that when light sources are replaced, only a qualified specialist can ensure that they are not contaminated and/or damaged. The service life of the light sources is directly affected by the mounting method with heat conducting pads. Therefore, the non-professional replacement of light sources and separate control gear is not considered advisable.

* **Sonderausführungen mit anderen Lichtleistungen, Farbwiedergabeindizes, Oberflächen, Kabel- und Rohrlängen auf Anfrage.**
Special versions products with other light outputs, colour rendering indices, surfaces, cable and tube lengths on request.

TRIAC **Diese Leuchten sind mit einem handelsüblichen Phasenabschnittsdimmer regelbar – sie können sowohl ein- und ausgeschaltet als auch in der Helligkeit stufenlos geregelt werden. Dafür ist eine 3-adrige Standard-Netzzuleitung ausreichend.**
Luminaires with this feature can be controlled with a standard phase cut dimmer – it can be switched on and off as well as continuously be controlled in brightness. A 3-wire standard mains cable is sufficient.

DALI **5-adrige Netzzuleitung bei Regelung über DALI oder 0/1–10 V erforderlich.**
0–10 V 5-core mains cable required for control via DALI or 0/1–10 V.
1–10 V

CCT **LED-Leuchten mit einer Farbtemperatur von 2700 K liefern wir kurzfristig.**
LED-Leuchten mit einer Farbtemperatur von 3000 K und höher haben in der Regel längere Lieferzeiten.
We supply LED lights with a colour temperature of 2700 K at short notice.
LED lights with a color temperature of 3000 K and higher usually have longer delivery times.

Lumen **Die Angaben zu Lichtstrom (Lumen) sind Nominalwerte, das heißt reine Modul-Lichtstromwerte.**
Der Lichtstrom gibt an, wieviel Licht nach allen Seiten abstrahlt.
The luminous flux (lumen) specifications are nominal values, i.e. pure module luminous flux values.
The luminous flux indicates how much light radiates in all directions.

D2W **Mit Dim2Warm wird eine Funktionalität der Leuchte bezeichnet, mit der das als angenehm empfundene Dimmverhalten von klassischen Glühfadenlampen imitiert wird. Beim Dimmen wird das Licht nicht nur dunkler, sondern ändert seine Lichtfarbe auch in den warmweißen Bereich.**
Dim2Warm refers to a luminaire functionality that imitates the pleasant dimming behavior of classic incandescent lamps. When dimmed, the light not only becomes darker, but also changes its colour to warm white tone.

TW **Leuchten mit der Tunable White Funktionalität besitzen eine variable Farbtemperatursteuerung von warm- bis kaltweißem Licht.**
Luminaires with the tunable-white functionality have variable colour temperature control from warm to cool white light.

CRI **Der Farbwiedergabeindex wird zur Beurteilung der Qualität der Farbwiedergabe einer Lichtquelle herangezogen.**
The colour rendering index is used to assess the quality of the colour rendering of a light source.

UGR **Bewertung der Blendung**
Unified Glare Rating

+C **kennzeichnet Produkte, in die ein vorprogrammiertes CASAMBI-Modul integriert ist.**

Die CASAMBI Funktionalität ist grundsätzlich für alle unsere Produkte einsetzbar. Für die verschiedenen Integrationsmöglichkeiten (abhängig von der Temperatur: in die Leuchte, in die abgehängte Decke, in den Schalter oder den Verteilerkasten) informieren wir Sie gerne. CASAMBI ist ein Bluetooth-basiertes Lichtsteuerungssystem, das vollständig in die Leuchte oder hinter den Schalter integriert werden kann. Es ist einfach und intuitiv über mobile Devices mit der kostenlosen CASAMBI-App (iOS und Android) bedienbar. CASAMBI erweitert so die Steuerungsmöglichkeiten um Funktionen wie Dimmen, Gruppieren von Leuchten, Programmieren von Gruppen und Szenen, Automatisierungen und vieles mehr. Für ausführlichere Informationen besuchen Sie bitte www.casambi.com

+C indicates products with pre-programmed CASAMBI module integrated in the luminaire.

The CASAMBI functionality is basically applicable to all our products. For the different possibilities of integration (depending on the temperature) – in the luminaire, in the suspended ceiling, in the switch or the distribution box) we will be pleased to inform you. CASAMBI is a lighting control system which is operated via Bluetooth and can be integrated completely into the luminaire or behind the light switch. It is controlled via mobile devices using the free CASAMBI app, making its operation simple and intuitive. CASAMBI expands the possibilities of control with new options such as dimming, the programming of specific scenarios or groups, automations and many more. For further information, please visit www.casambi.com.



Eine Excel-Datei mit Artikelnummern und aktuellen Preisen stellen wir unseren Handelspartnern gerne zur Verfügung unter:
www.serien.com/downloads/

We are happy to make the Excel file with article numbers and current prices available to our trade partners:
www.serien.com/downloads



Unter www.serien.com/downloads finden Sie hilfreiche Informationen und die jeweils aktuellen technischen Daten: Datenblätter, Kataloge, Preislisten, Lichttechnische Daten (EULUMDAT), 3D CAD-Daten, Konformitätserklärungen, Retourenformular, FAQs, Montageanleitungen, Bohrschablonen und weitere Serviceanleitungen

At www.serien.com/downloads you will find helpful information and the latest technical data:
Data sheets, catalogues, price lists, lighting data (EULUMDAT), 3D CAD data, declarations of conformity, returns form, FAQs, assembly instructions, drilling templates and other service instructions.

Awards

ANNEX

2013	German Design Award, Nominierung
2012	Design Plus
2011	Internationaler Designpreis Baden-Württemberg, Focus Silber

APP

2017	German Design Award, Special Mention
2016	Design Plus
2016	Iconic Award, Interior Innovation, Winner

CAVITY

2019	German Design Award, Winner
2019	Nominierung Leuchte des Jahres

CURLING

2020	Innovationspreis Architektur+Technik
2018	German Design Award, Winner
2016	Internationaler Designpreis Baden-Württemberg, Focus Silber
2016	Iconic Award, Interior Innovation, Best of Best

CRIB

2019	German Design Award, Winner
------	-----------------------------

ELANE

2012	Deutscher Designer Club, Gute Gestaltung, Bronze
------	--

JOB

2011	Designpreis der Bundesrepublik Deutschland, Nominierung
2010	Deutscher Designer Club, Gute Gestaltung, Silber
2009	The Israel Museum, Collection

JONES

1999	Red Dot Design Award
------	----------------------

LID

2018	Iconic Award, Innovative Interior, Best of Best
------	---

ONE EIGHTY

2011	Designpreis der Bundesrepublik Deutschland, Nominierung
2010	Red Dot Design Award, Winner

PROPELLER

2009	Designpreis der Bundesrepublik Deutschland, Nominierung
2009	The Israel Museum, Collection
2008	Red Dot Design Award, Winner

REEF

2006	Designpreis der Bundesrepublik Deutschland, Nominierung
2004	Red Dot Design Award, Winner
2004	Design Plus
2004	Designpreis der Bundesrepublik Deutschland, Nominierung
2003	Internationaler Designpreis Baden-Württemberg, Focus Silber

ROD

2019	Iconic Award, Innovative Interior, Best of Best
------	---

REFLEX²

2022	Internationaler Designpreis Baden-Württemberg, Special Mention
2022	German Design Award, Winner (Floor)
2022	Iconic Award, Innovative Interior, Best of Best
2021	Stylepark Selected
2021	Internationaler Designpreis Baden-Württemberg, Special Mention
2020	Design Plus
2020	German Design Award, Winner (Ceiling)

SEVENTY SEVEN

1991	iF Product Award
1991	Stedelijk Museum Amsterdam, Collection

SLANT

2013	German Design Award, Nominierung
2012	Deutscher Designer Club, Gute Gestaltung, Silber

SLICE

2015	German Design Award, Nominierung
------	----------------------------------

SLICE² PI

2023	Internationaler Designpreis Baden-Württemberg, Focus Gold
------	---

SML

2006	Designpreis der Bundesrepublik Deutschland, Nominierung
2004	Red Dot Design Award, Winner
2004	Designpreis der Bundesrepublik Deutschland
2003	Internationaler Designpreis Baden-Württemberg, Focus Silber

SML²

2014	German Design Award, Nominierung
2013	Designpreis der Bundesrepublik Deutschland, Nominierung
2013	Red Dot Design Award, Winner

SML T5

2004	Design Plus
2004	Designpreis der Bundesrepublik Deutschland
2004	iF Product Award, Winner
2003	Internationaler Designpreis Baden-Württemberg, Focus Silber

TWIN

2015	German Design Award, Gold
2014	Design Plus

ZOOM

2007	Designpreis der Bundesrepublik Deutschland, Nominierung
2004	Designpreis der Bundesrepublik Deutschland, Nominierung
2003	Red Dot Design Award, Winner
2003	Internationaler Designpreis Baden-Württemberg, Focus Gold

Service

Bei Fragen zu unseren Produkten, deren Lieferbedingungen und Verfügbarkeiten kontaktieren Sie bitte unser Serviceteam.

For questions about our products, their delivery conditions and availabilities, please contact our customer service any time.

+49 6106 6909 0
serien@serien.com
www.serien.com

Business Contacts

Gebiet Nord/Ost

PLZ 0, 1 - 39
PLZ 99

serien Raumeuchten GmbH
Dzenan Ganibegovic

Hainhäuser Straße 3-7
63110 Rodgau
Germany

E dzenan.ganibegovic@serien.com
M +49 151 5122 1212
T +49 6106 6909 248

Gebiet West/Mitte

West PLZ 48 - 49 und 57 - 59
Mitte PLZ 60 - 65

serien Raumeuchten GmbH
Dzenan Ganibegovic

Hainhäuser Straße 3-7
63110 Rodgau
Germany

E dzenan.ganibegovic@serien.com
M +49 151 5122 1212
T +49 6106 6909 248

Gebiet West/Süd

West PLZ 40 - 47 und 50 - 56
Süd PLZ 66 - 98

serien Raumeuchten GmbH
Helmuth Grischy

Hainhäuser Straße 3-7
63110 Rodgau
Germany

E helmuth.grischy@serien.com
M +49 151 5092 8656
T +49 6106 6909 252

Austria

serien Raumeuchten GmbH
Peter Salat

Hainhäuser Straße 3-7
63110 Rodgau
Deutschland

E peter.salat@serien.com
M +49 179 496 57 43
T +49 6106 6909 232

Switzerland

wirzpartner GmbH
für Leuchten und Licht

Werner-Weber-Str. 11
8630 Rüti
Schweiz

E info@wirzpartner.ch
M +41 79 290 30 08
T +41 55 260 19 60

Benelux

serien Raumeuchten GmbH

Hainhäuser Straße 3-7
63110 Rodgau
Germany

E serien@serien.com
T +49 6106 6909 0

Brasil

FAS iluminação

Alameda Gabriel Monteiro da Silva,
n° 413 Jardim America
00.817.414/0001-08 – São Paulo
Brazil

E atendimento@fasiluminacao.com.br
T +55 11 30861661
M +55 11 94713-9743

Australia

Archebiosis Architects
Edith Clark

Shop 3B, 780 Bourke Street
NSW 2016 Redfern
Australia

E edith@archebiosis.com
T +61 2 83992334

Greece & Cyprus

Christos Keletzis

Werrastr. 42
60486 Frankfurt
Germany

E christos.keletzis@serien.com
T +49 171 5725684

Portugal

In-One
Manuela Peres

EN 125
8100-068 Benfarras/Boliqueime
Portugal

E manuelaperes@in-one.pt
T +35 1938460199

Worldwide

We are distributing worldwide.

Please contact our customer
service for more information:

E serien@serien.com
T +49 6106 6909 0

Impressum Imprint

serien Raumleuchten GmbH, HRB 22042 Amtsgericht Offenbach. Geschäftsführer/Managing Directors: Jean-Marc da Costa, Manfred Wolf. Copyright: serien Raumleuchten GmbH 2023. **Alle Rechte vorbehalten. Keine Reproduktionen ohne vorherige schriftliche Zustimmung. Alle Marken sind registriert. Alle Produkte sind gesetzlich geschützt. Verstöße werden in vollem Umfang strafrechtlich verfolgt. Änderungen vorbehalten.** All rights reserved. No reproductions without prior written consent. All trademarks are registered. All products are protected by law. Infringements will be prosecuted to the fullest extent. Subject to alteration without notice. **Konzeption** Concept: serien.lighting; **Projektleitung** Projektmanagement: Nina da Costa **Gestaltung** Graphic Design: Sandra Doeller; **Renderings** serien.lighting – preyer3d.de **Postproduction** David Helmrich, Sebastian Hübner, Peter Schladoth, Nicola Riva **Druck** Printing: pruskil

THANK YOU to hosts, artists and photographers:

Cover Foto Haus B, München DE – Studio Olaf Becker; **04 ANNEX** Ceiling: products – Christoph Lison; **06 CAVITY** Ceiling: products – serien.lighting; **08 CURLING** Ceiling: products – Christoph Lison, 3D serien.lighting; **12 DRAFT** Ceiling: products – serien.lighting, preyer3d.de; **26 ANNEX** Ceiling: products – Christoph Lison; **27 ANNEX** Ceiling M: Next Munich GmbH, München DE – Studio Olaf Becker; **28 ANNEX** Ceiling M: Privat, Frankfurt am Main DE – Christoph Lison; **29 ANNEX** Ceiling M: Frank Landau, Frankfurt am Main DE – Farideh Fotografie; **30 ANNEX** Ceiling L: Seven Swans, Frankfurt am Main DE – Ingmar Kurth; **31 ANNEX** Ceiling M: Universitätsbibliothek Bern, Bern CH – Studio Olaf Becker; **33 CAVITY** Ceiling S: appartement/showroom, Bayern DE, www.stephanie-thatenhorst.com – Studio Olaf Becker; **34 CURLING** Ceiling M: Privat, Frankfurt am Main DE – Farideh Fotografie; products – Christoph Lison, 3D serien.lighting; **35 CURLING** Ceiling M: Privat, Frankfurt am Main DE – Farideh Fotografie; **36/37 CURLING** Ceiling S: hauser lacour, Frankfurt am Main DE – Farideh Fotografie; **38/39 CURLING** Ceiling M: Himmelrich, Luzern CH – Studio Olaf Becker; **40 DRAFT** Ceiling: products – serien.lighting, preyer3d.de; **41 DRAFT** Ceiling M: Privat, Stuttgart DE, www.nowherearchitekten.de – Studio Olaf Becker; **42 DRUM** Ceiling: products – serien.lighting, preyer3d.de; **43 DRUM** Ceiling M short: Privat, Brüssel BE – Studio Olaf Becker; **44 DRUM** Ceiling M long: Privat, Stuttgart DE, www.nowherearchitekten.de – Studio Olaf Becker; **45 DRUM** Ceiling M short: Office, Bozen IT – Studio Olaf Becker; **46 POPPY** Ceiling 5: Uli Holzinger, Frankfurt am Main DE – Ingmar Kurth; **47 REEF** Ceiling: Karl Henschel, Offenbach am Main – Ingmar Kurth; Product – Christoph Lison; **48 REFLEX²** Ceiling M 150: appartement/showroom, Bayern DE, www.stephanie-thatenhorst.com – Studio Olaf Becker; **49 REFLEX²** Ceiling M 300: Haus B, München DE – Studio Olaf Becker; **50 REFLEX²** Ceiling M 450: Product – serien.lighting, preyer3d.de; **51 REFLEX²** Ceiling S 600: Ingmar Kurth, Frankfurt am Main DE; **52 REFLEX²** Ceiling M 450: Haus B, München DE – Studio Olaf Becker; **53 REFLEX²** Ceiling M 450: Haus B, München, DE – Studio Olaf Becker; **54 SLICE²** PI Ceiling: products – serien.lighting, preyer3d.de; **55 SLICE²** PI Ceiling: Ingmar Kurth; **58 ANNEX** Suspension: products – Christoph Lison; **60 CAVITY** Suspension: products – serien.lighting, preyer3d.de; **63 CURLING** Suspension: products – Christoph Lison, 3D serien.lighting; **66 DRAFT** Suspension: products – serien.lighting, preyer3d.de; **70 ONE EIGHTY** Suspension: products – Christoph Lison; **78 ANNEX** Suspension L: Prasad&Schwarck, Frankfurt am Main DE – Christoph Lison; **79 ANNEX** Suspension M: Next Munich GmbH DE – Studio Olaf Becker; **80 CAVITY** Suspension L: Bürgeramt der Stadt Frankfurt am Main DE, www.jacoby-architects.de – Studio Olaf Becker; **81 CAVITY** Suspension: products – serien.lighting, preyer3d.de; **82 CAVITY** Suspension S: Privat, Stuttgart DE, www.nowherearchitekten.de – Studio Olaf Becker; **83 CAVITY** Suspension S: Wohnung K, München, DE – Studio Olaf Becker; **84 CURLING** Suspension Rope L: Himmelrich, Luzern CH – Studio Olaf Becker; **85 CURLING** Suspension: products – serien.lighting, preyer3d.de; **86 DRAFT** Suspension Rope M: M4 Offices, München DE – Studio Olaf Becker; **87 DRAFT** Suspension Rope S/M: Privat, Stuttgart DE, www.nowherearchitekten.de – Studio Olaf Becker; **88 DRUM** Suspension Rope M: Ingmar Kurth, Frankfurt am Main DE; **89 DRUM** Suspension Tube M: Schule, München DE – Studio Olaf Becker; **90 ONE EIGHTY** Suspension L Adjustable: Moon Dog Studio, Frankfurt am Main DE – Ingmar Kurth; **91 ONE EIGHTY** Suspension L Adjustable: Restaurant Margarete, Frankfurt am Main DE – Christoph Lison; **92 POPPY** Suspension: Tony McNeveins, Wiesbaden DE – Ingmar Kurth; **93 PROPELLER**: Product – Christoph Lison; **94 REEF** Suspension 3: Moon Dog Studio, Frankfurt am Main DE – Ingmar Kurth; **95 TWIN**: Schmidt Apartment, Frankfurt am Main DE – Ingmar Kurth; **96 ZOOM 3**: MHK Küchen, Dreieich DE – Studio Olaf Becker; **97 ZOOM 1**: Privat, CH – Heinz Dahinden; **98 ZOOM XL**: bigstock.com – David Helmrich; **99 ZOOM XL 2**: Café Wacker, Frankfurt am Main DE – Jean-Marc da Costa; **102 APP** Wall: products – Christoph Lison; **104 CAVITY** Wall: products – serien.lighting, preyer3d.de; **107 CRIB** Wall: Products – serien.lighting, preyer3d.de; **108 CURLING** Wall: products – serien.lighting, preyer3d.de; **110 LID** Wall: products – serien.lighting, preyer3d.de; **116 REEF** Wall – Christoph Lison; **117 REFLEX** Wall: products – serien.lighting, preyer3d.de; **118 ROD** Wall: products – serien.lighting, preyer3d.de; **126 APP** Wall: Privat, Frankfurt am Main DE – Farideh Fotografie; **127 APP** Wall: Privat, Frankfurt am Main DE – Ingmar Kurth; **128 CAVITY** Wall S: Privat, Stuttgart DE, www.nowherearchitekten.de – Studio Olaf Becker; **129 CAVITY** Wall S: products – serien.lighting, preyer3d.de; **130 CLUB** Wall: Restaurant Margarete, Frankfurt am Main DE – Ingmar Kurth; **131 CURLING** Wall S/M: Haus B, München DE – Studio Olaf Becker; **132/133 CURLING** Wall M: Himmelrich, Luzern CH – Studio Olaf Becker; **134 CRIB** Wall: Ingmar Kurth, Frankfurt am Main DE; **135 CRIB** Wall: Haus B, München DE – Studio Olaf Becker; **136 LID** Wall IP44: Goethequartier, Offenbach DE – Christoph Lison; **137 LID** Wall: Office, Planegg DE, Ricardo Alves GmbH – Studio Olaf Becker; **138 LID** Wall: Privathaus, Budapest HU – Christoph Lison; **139 LID** Wall: products – serien.lighting, preyer3d.de; **140 POPPY** Wall 2: Uli Holzinger, Frankfurt am Main DE – Ingmar Kurth; **141 REEF** Wall: products – Christoph Lison; **142 REFLEX²** Wall 300 – Christoph Lison; **143 REFLEX²** Wall 300: products – serien.lighting, preyer3d.de; **144 ROD** Wall: Weingut Alfred Kühle, Frankfurt am Main DE – Ingmar Kurth; **145 ROD** Wall: Haus B, München DE – Studio Olaf Becker; **146 SML** Wall: Wohnung B, Berlin DE – Ingmar Kurth; **147 SML²** Wall 300: Universitätsbibliothek Bern, Bern CH – Studio Olaf Becker; **148 SML²** Wall 220: Soho Turley, Mannheim DE – Farideh Fotografie; **149 SML²** Wall 220: Shift, Frankfurt am Main DE – Christoph Lison; **150 SML** Wall: products – Christoph Lison; **151 SML** Wall: Bettmeralp, CH – Thomas Andenmatten; **155 REFLEX** Table: products – serien.lighting, preyer3d.de; **160 JOB** Table: Doris Fratton DE – Ingmar Kurth; **161 POPPY** Table: Juan Amador Suite DE – Christoph Lison; **162/163 REFLEX²** Table: Privat, Stuttgart DE, www.nowherearchitekten.de – Studio Olaf Becker; **164 SLICE²** Furniture Chrome: Office Westend, Frankfurt am Main DE – Christoph Lison; **165 SLICE²** Furniture Chrome: Zollverein School, Essen DE – Ingmar Kurth; **172 REFLEX²** Floor: products – serien.lighting, preyer3d.de; **178/179 CENTRAL** Floor: Privat, Frankfurt am Main DE – Ingmar Kurth; **180 CLUB** Floor: products – Christoph Lison; **181 CLUB** Floor: Haus B, München DE – Studio Olaf Becker; **182 CLUB** Floor: Haus B, München DE – Studio Olaf Becker; **183 CLUB** Floor: Wohnung K, München DE – Studio Olaf Becker; **184 JONES** Floor: Privat, Frankfurt am Main DE – Farideh Fotografie; **185 JONES** Floor: Privat, Frankfurt am Main DE – Farideh Fotografie; **186/187 POPPY** Floor: Liv Johansson Weicker, Darmstadt DE – Farideh Fotografie; **188 REFLEX²** Floor S: Wohnung K, München DE – Studio Olaf Becker; **189 REFLEX²** Floor M: Privat, Stuttgart DE, www.nowherearchitekten.de – Studio Olaf Becker; **190 REFLEX²** Floor S: Haus B, München DE – Studio Olaf Becker; **191 REFLEX²** Floor M: Weingut Alfred Kühle, Frankfurt am Main DE – Ingmar Kurth; **192/193 REFLEX²** Floor S 100: Privat, Stuttgart DE, www.nowherearchitekten.de – Studio Olaf Becker; **194 SLICE²** Floor: 2030 Agentur für Kommunikation, München DE – Studio Olaf Becker; **195 SLICE²** Floor: M4 Offices, München DE – Studio Olaf Becker; **198 DRAFT** Suspension M: Ingmar Kurth, Frankfurt am Main DE

Mit Erscheinen dieser Preisliste verlieren alle bisherigen Preislisten ihre Gültigkeit. Die angegebenen Bruttopreise enthalten den zum Zeitpunkt der Drucklegung in Deutschland gültigen Mehrwertsteuersatz von 19%. Die dargestellten Produktzeichnungen dienen der Illustration. Auch wenn bei deren Erstellung mit großer Sorgfalt vorgegangen wurde, können einzelne Proportionen vom tatsächlichen Produkt abweichen. Alle Maße in Millimetern, sofern nicht anders angegeben. Für alle Aufträge gelten die Liefer- und Zahlungsbedingungen der serien Raumleuchten GmbH. Änderungen und Irrtümer vorbehalten. Preisanpassungen sind auch während der Preislistenlaufzeit möglich.

This price list supersedes all previously published price lists. The gross prices shown include the german value added tax rate of 19% valid at the time of printing. Retail prices may differ with local sales taxes applied. The drawings shown in this document are for informational purposes only. Although great care has been taken when creating them, their proportions may not correctly reflect the proportions of the real product. All dimensions are millimetres unless specifically declared otherwise. All orders are accepted subject to the Conditions of Sale of serien Raumleuchten GmbH. Subject to alteration without notice. Prices may be adjusted during the period covered by the price list.



scan for PDF



@serien.lighting
www.serien.com