

# Baldachinprofil 3

Design da Costa & Wolf



**D** Vor Montage, Leuchtmittelwechsel und Reinigung Leuchte vom Netz trennen!  
Die Leuchte nur im Innenbereich einsetzen! Nur von Elektrofachkraft anzuschließen!

**GB** Prior to assembly, changing the lamp or cleaning the luminaire please detach  
it from the mains. For indoor use only. Installation by qualified personnel only.

**F** Prière de couper le courant avant tout montage, changement d'ampoule et nettoyage.  
Ce luminaire est réservé à un usage en intérieur. Installation par personnel qualifié uniquement.

**I** Antes de proceder al montaje, el cambio de bombilla y la limpieza desconecte la lámpara de la red  
eléctrica. Instale la lámpara sólo en un lugar interior. Installazione da personale qualificato sólo.

**E** Scollegare la lampada dalla rete elettrica prima del montaggio, della sostituzione del corpo illuminante  
e della pulizia. La lampada è adatta esclusivamente per interni. Instalación por personal cualificado sólo.

**NL** Voor montage, vervanging en reiniging de lamp van het stroomnet loskoppelen.  
De lamp alleen binnen gebruiken. Om alleen te verbinden door een erkend elektricien.



6x



4x



3x



3x

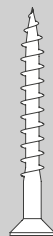

3x



1x

01

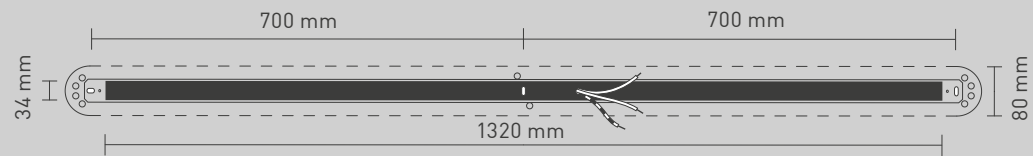

Ø 6 mm



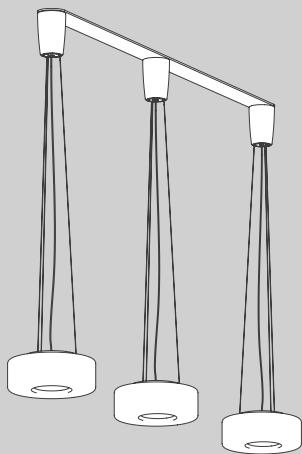

CURLING Suspension

→03

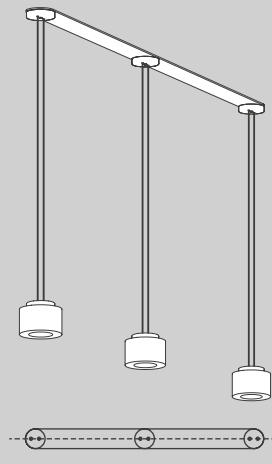
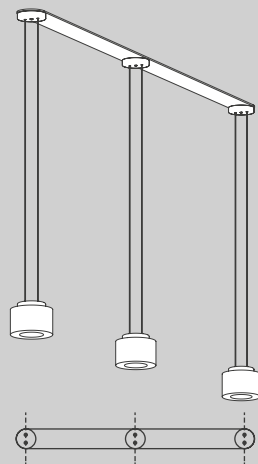

REEF Suspension

LED →08

Halogen →16

LED →12

Halogen →20

02

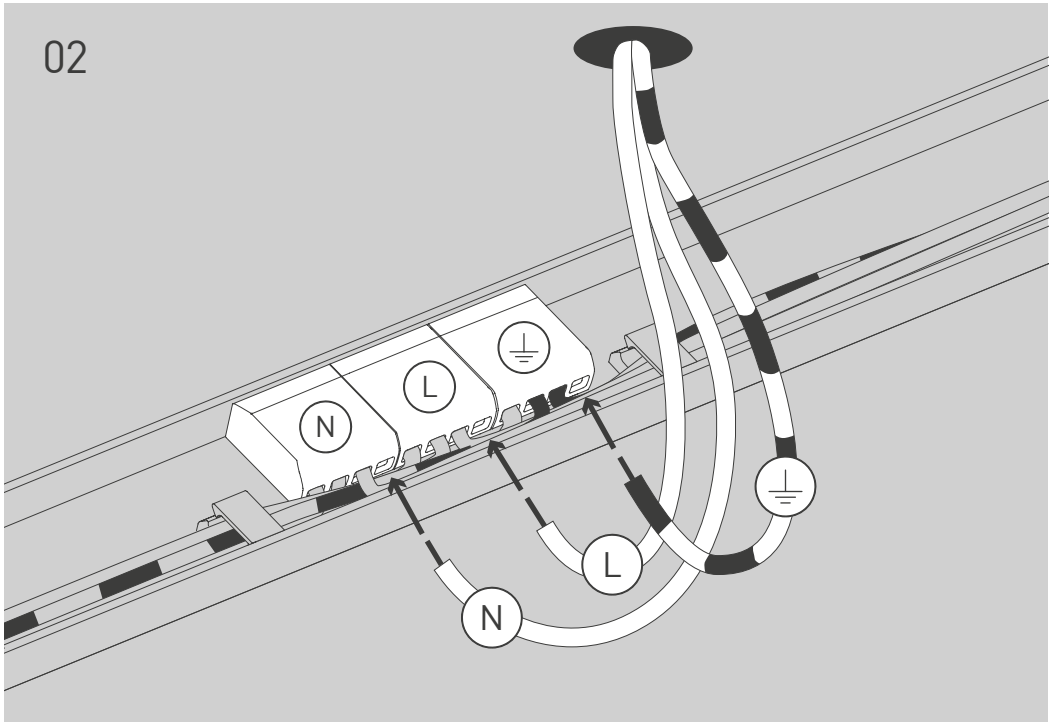

03

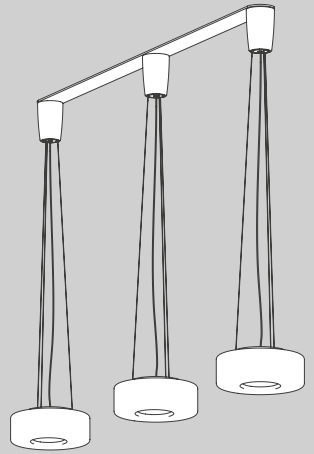

CURLING Suspension

04

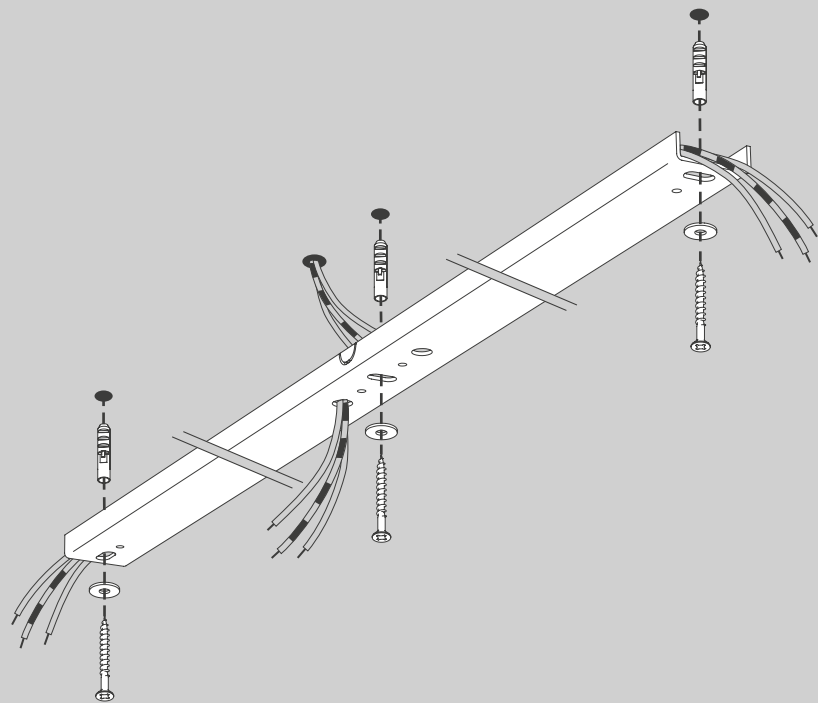

05

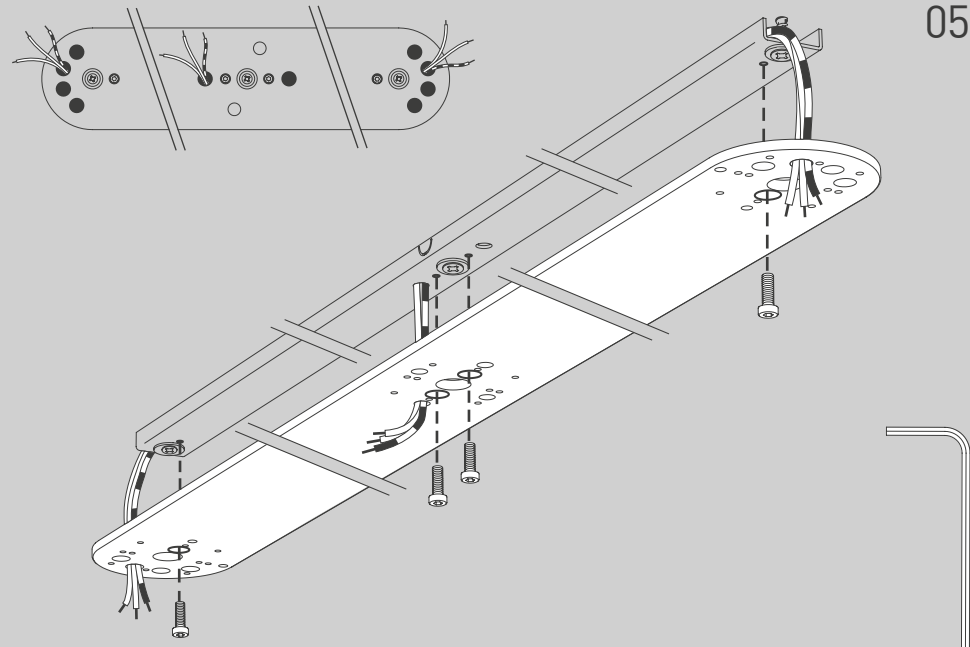

06

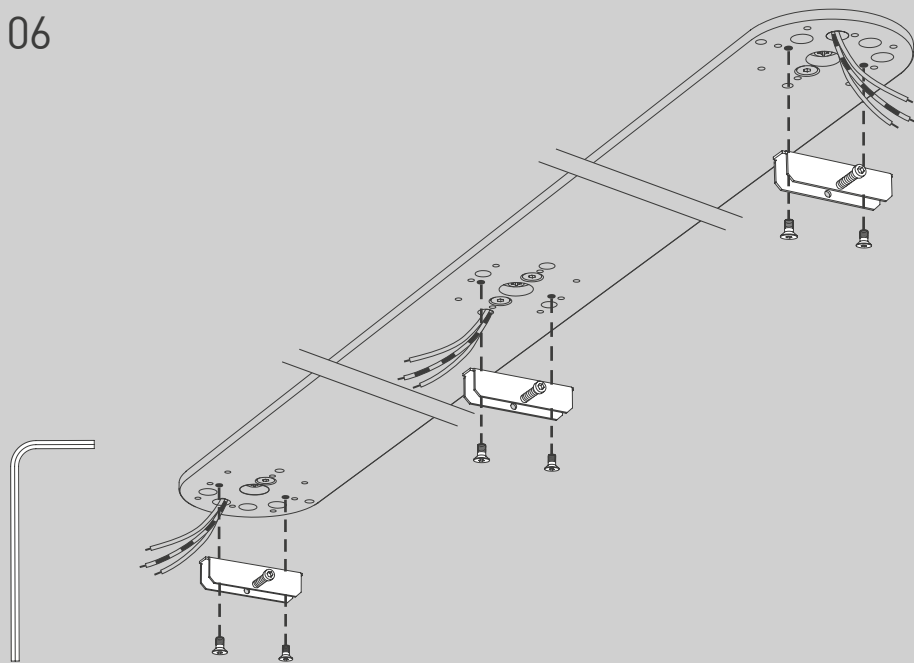

07

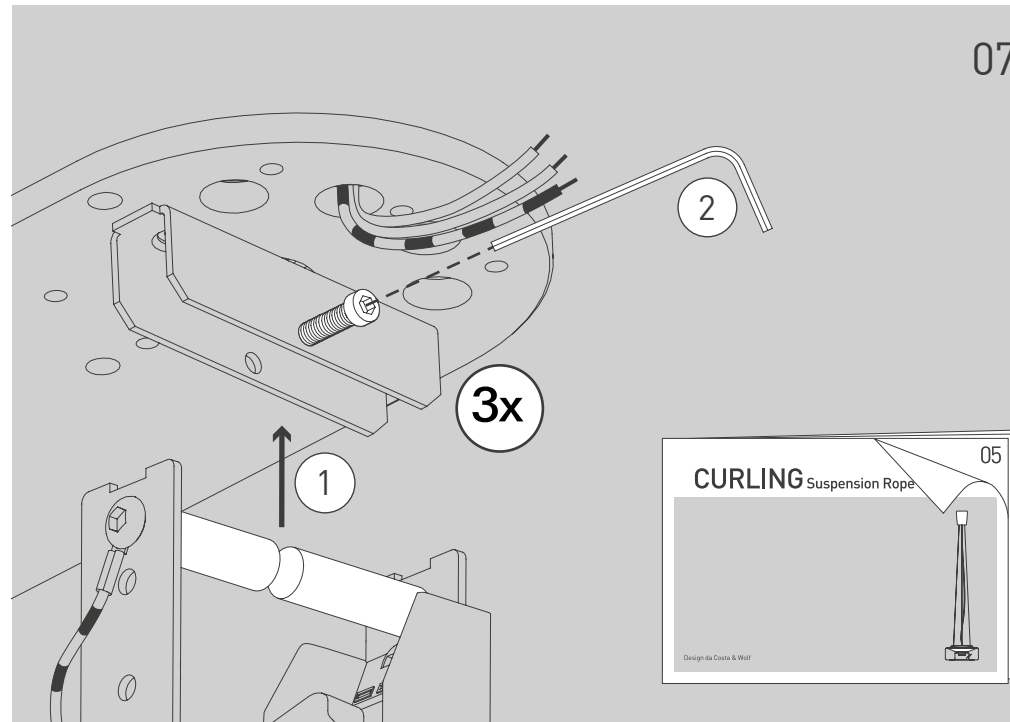

08

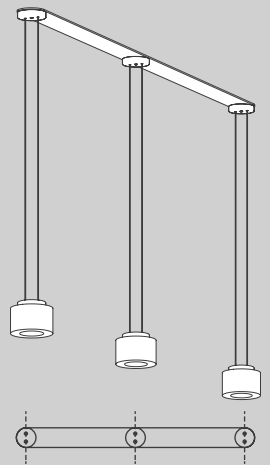

REEF Suspension LED

09

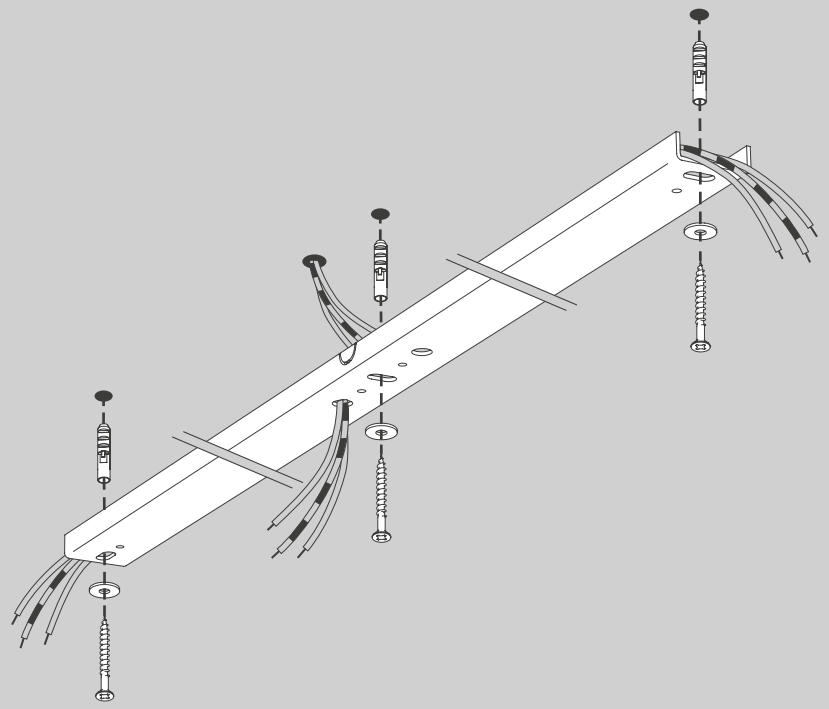



10

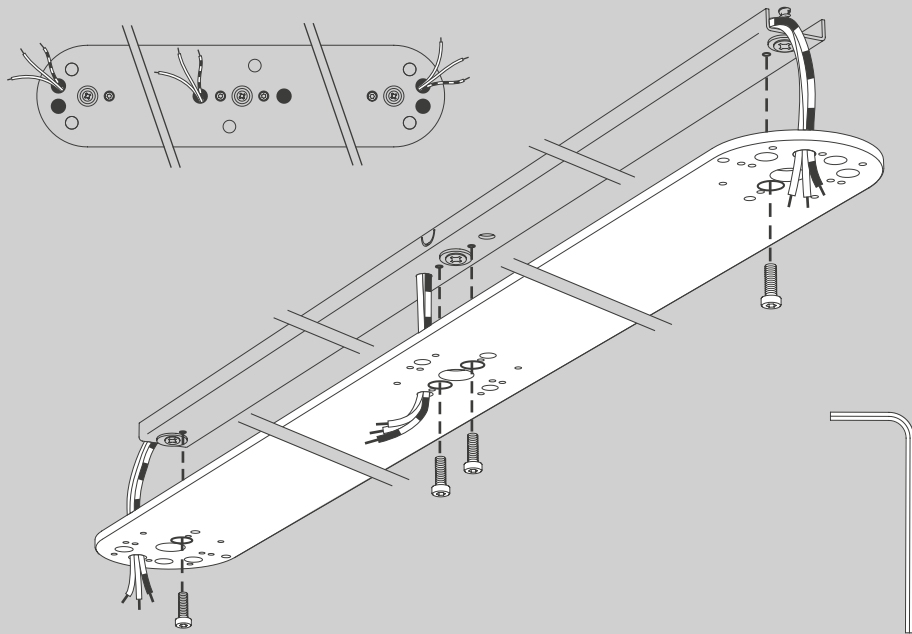

11

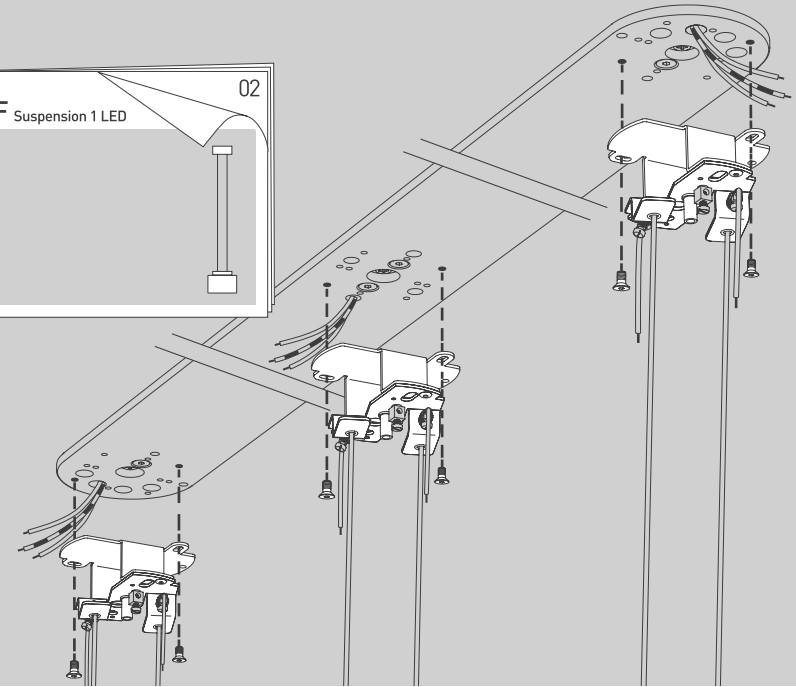
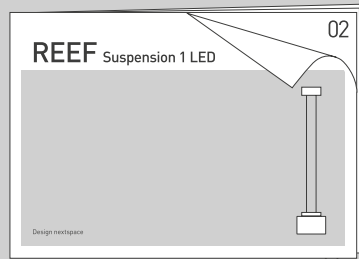

12

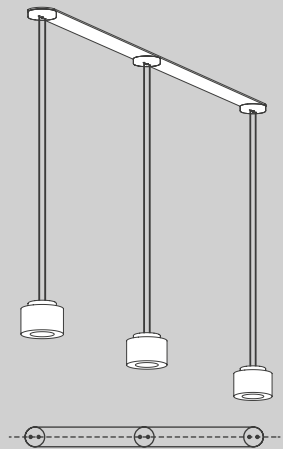

REEF Suspension LED

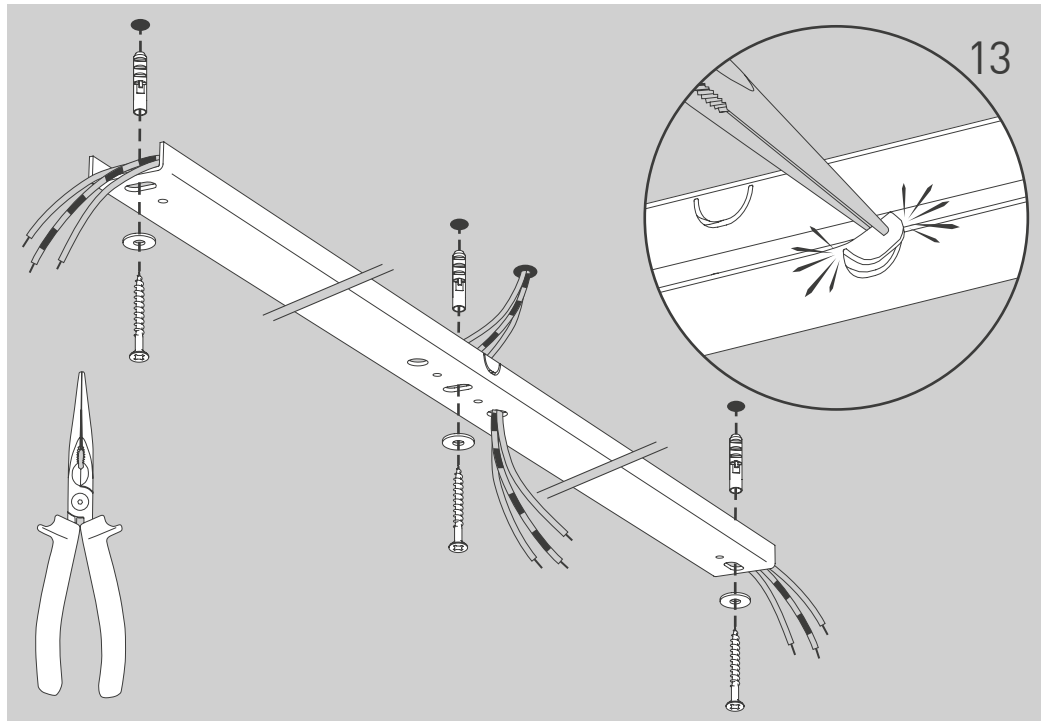

13

14

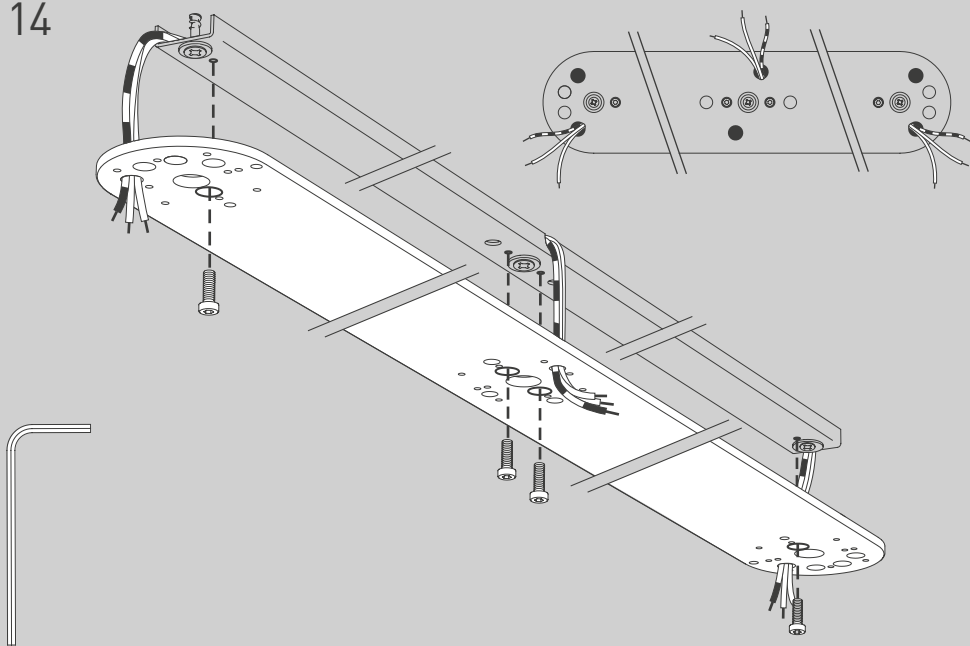

15

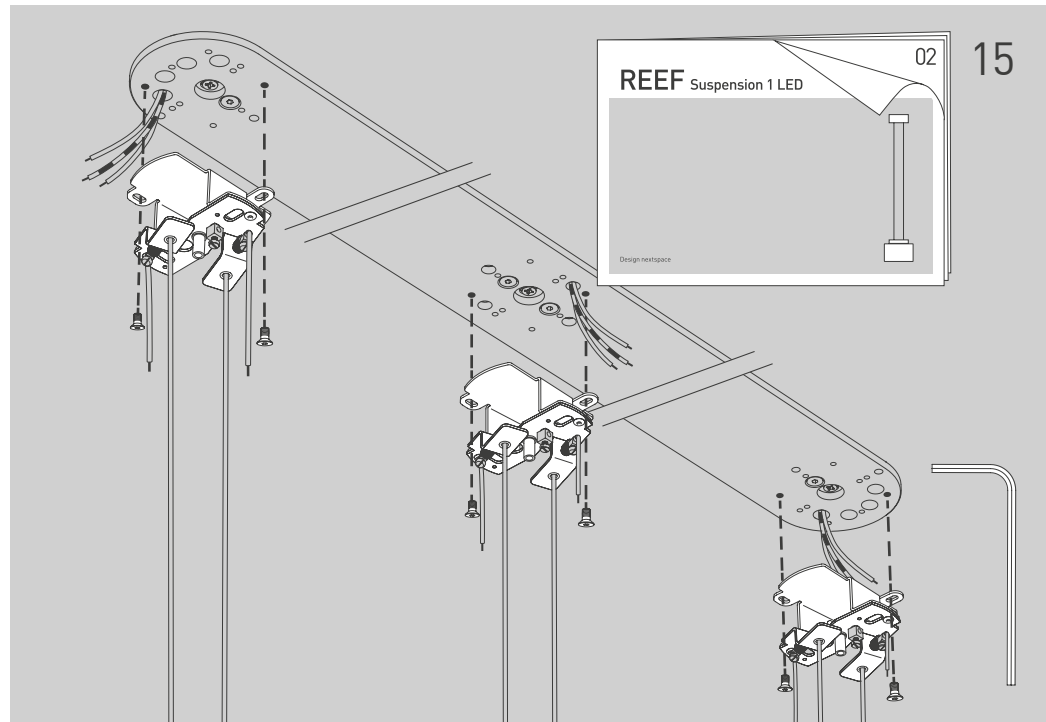

16

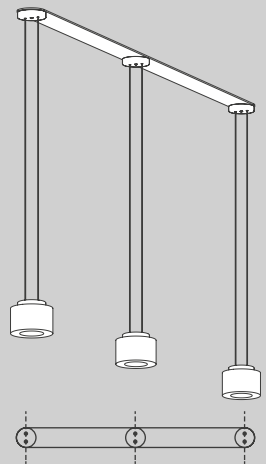

REEF Suspension Halogen

17

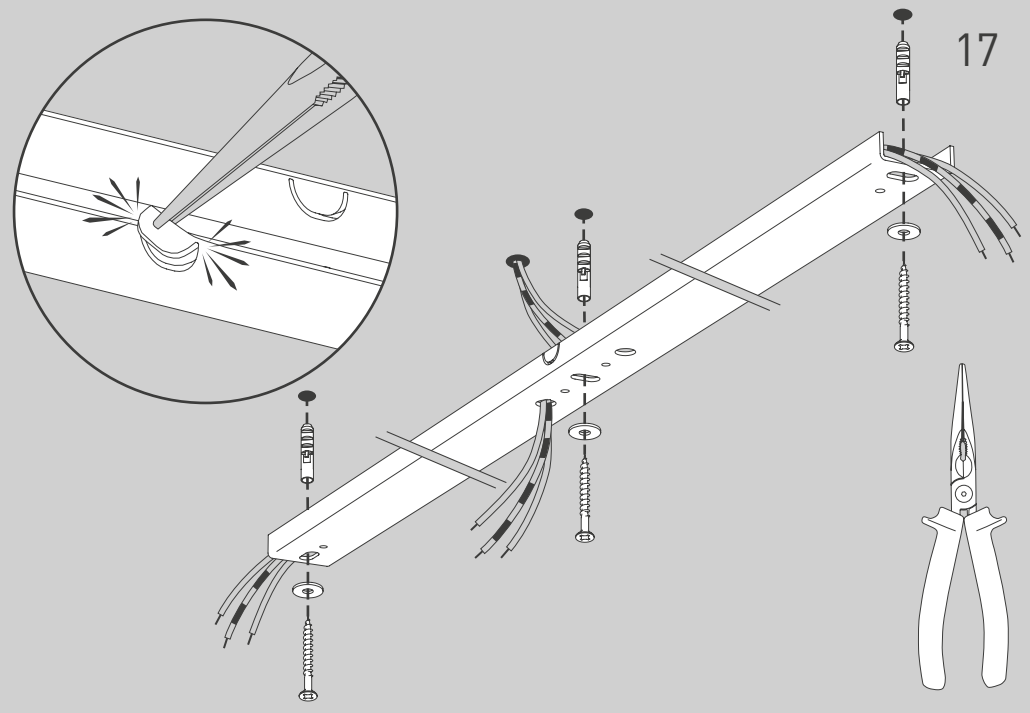

18

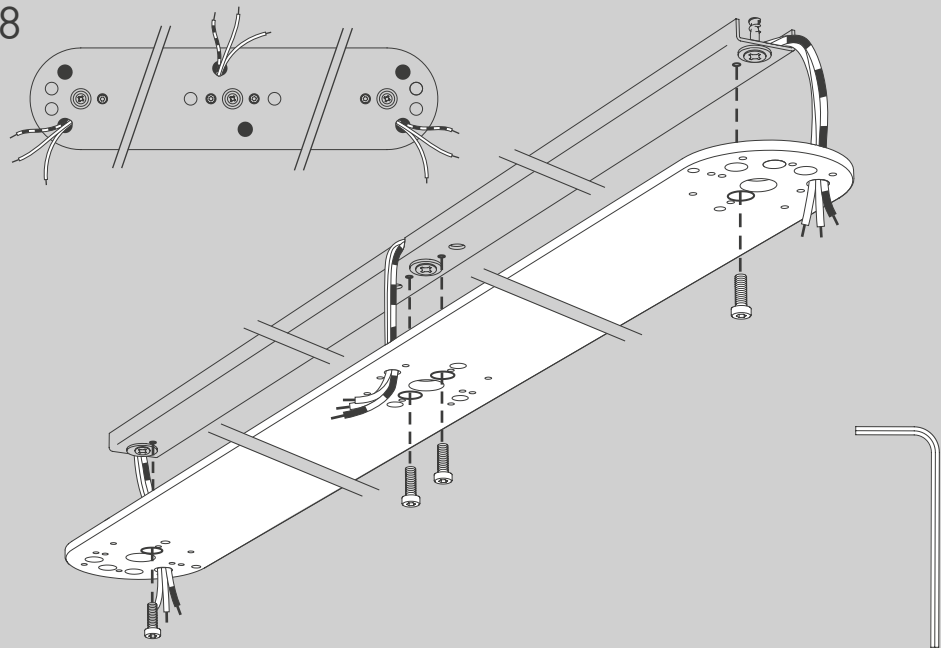

REEF Suspension 1 Halogen

02

Design nextspace

19

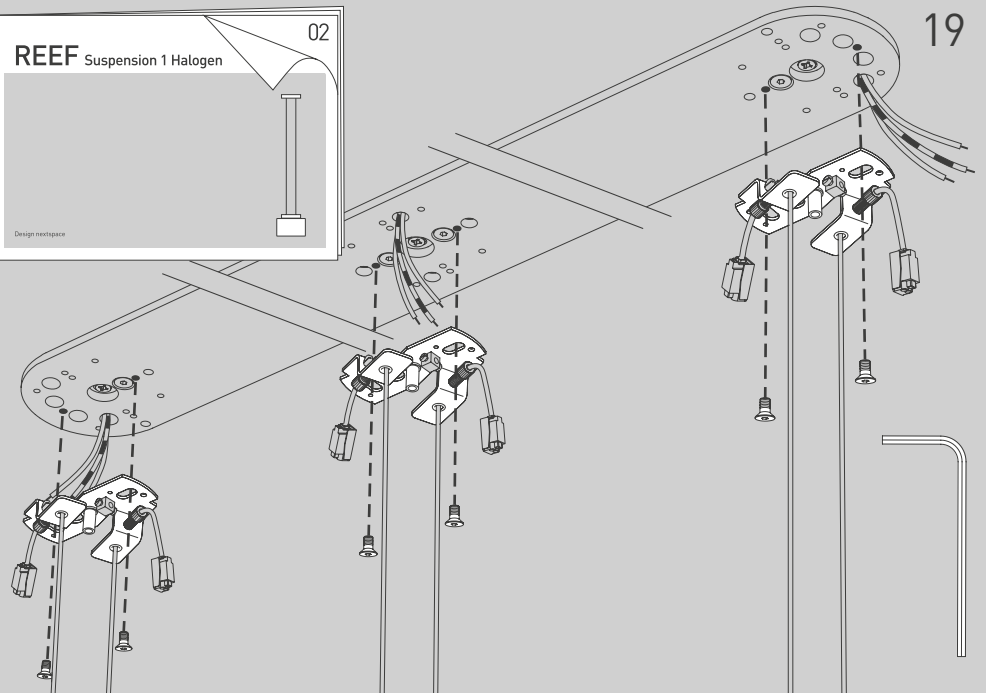

20

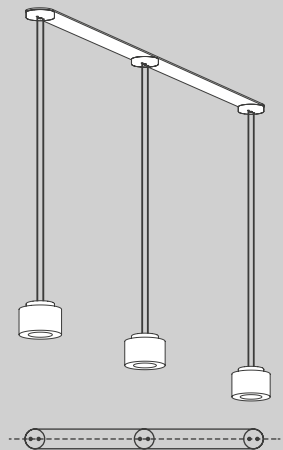

REEF Suspension Halogen

21

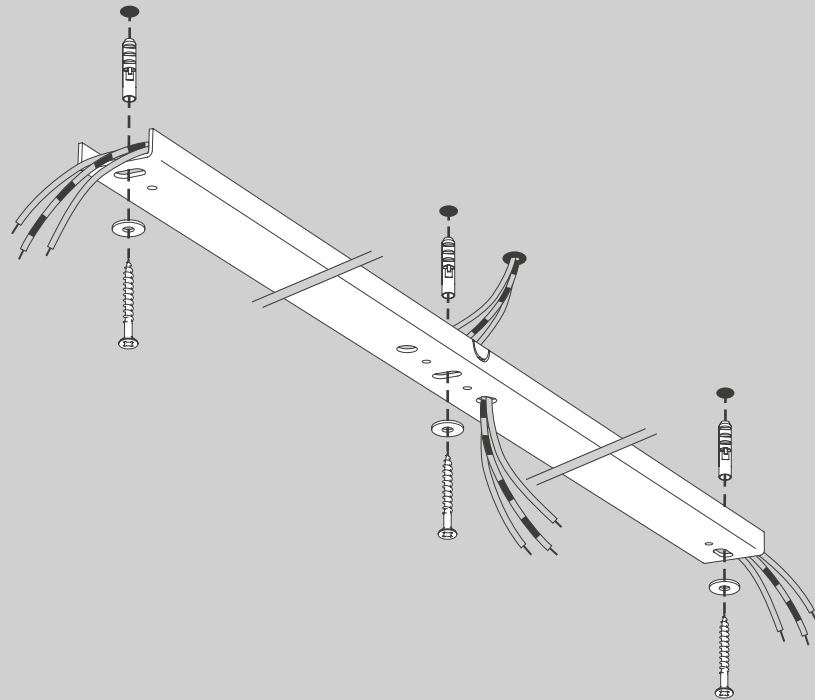

22

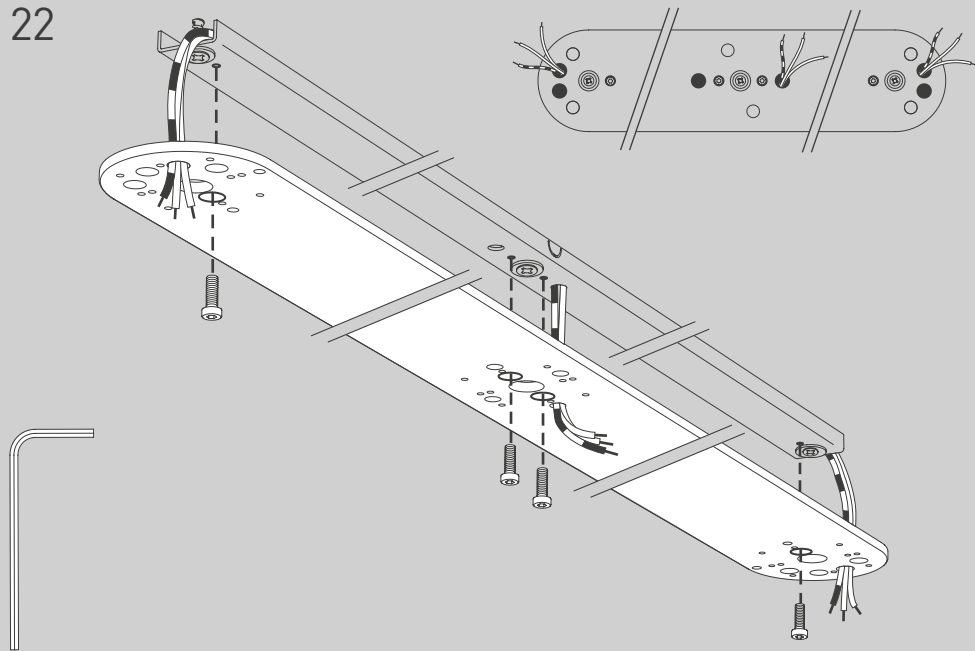

23

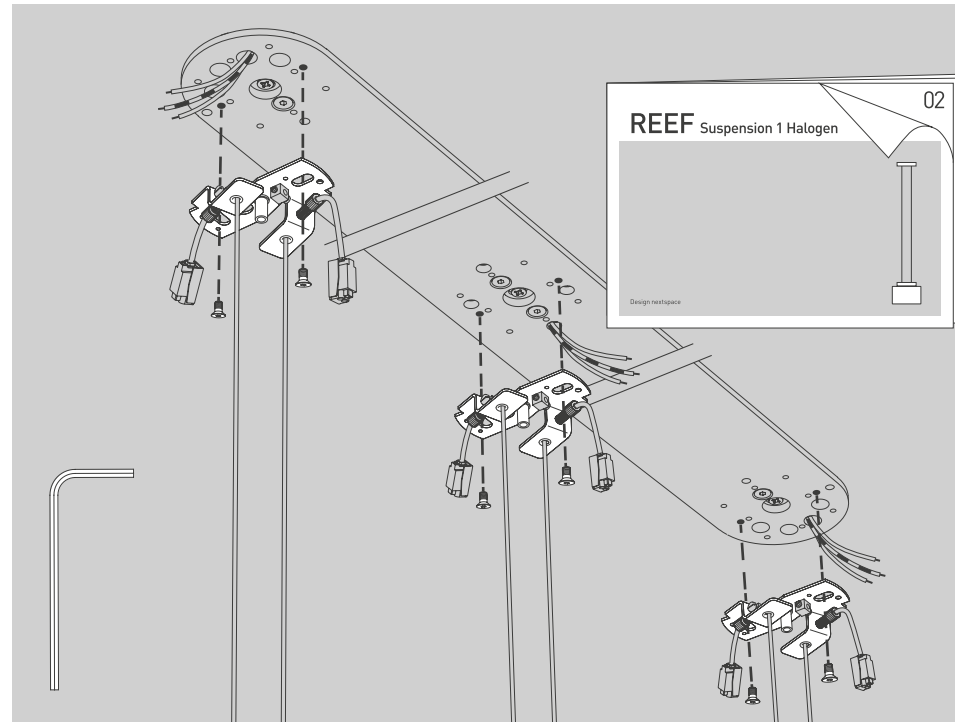

- D** Technische Änderungen und Irrtümer vorbehalten.
- GB** Subject to technical modifications and errors.
- F** Sous réserve de modifications techniques et d'erreurs.
- I** Ci riserviamo eventuali modifiche tecniche o errori.
- E** Se reserva el derecho a realizar modificaciones técnicas.
- NL** Error en technische wijzigingen voorbehouden.

### Baldachinprofil 3

mm



kg

3 kg





serien  
.lighting

serien Raumleuchten GmbH Hainhäuser Str. 3-7 63110 Rodgau Germany Tel +49 (0)6106 6909 0 [www.serien.com](http://www.serien.com)