

DRUM

Data Sheet

Suspension Tube



DRUM Suspension M Tube long



DRUM Suspension M Tube short



DRUM Suspension M Tube long

The DRUM luminaire family adds 4 cylindrical shapes to our product range. The respective combination gives rise to a geometric interplay of clear cylinders and cones with different angles on the inside. A transparent glass cylinder and matte internal reflector make for an appealing geometrical contrast and together become a luminaire with perfectly balanced light.

Examples of applications: With its graphic appearance, DRUM Suspension Tube fits perfectly into clean-cut architecture, the contract world, private spaces, and offices. With DRUM, the size and alignment of the inner body are always based on the height and diameter of the outer body. DRUM Suspension Tube is ideal for corridors or stairwells.

Design Jean-Marc da Costa

DRUM

Suspension Tube

Material

Surfaces



glass S short

glass S long

glass M short

glass M long

Housing

Aluminum mirror polished

Shade

Mouth blown glass

Reflector

Polycarbonate opal

Variations

short S

long S

short M

long M

Dimensions in mm

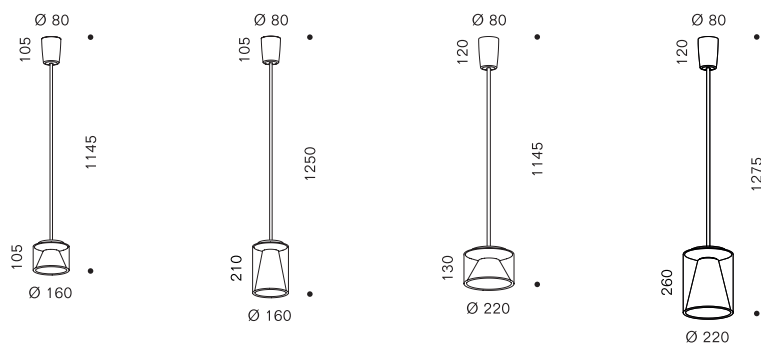

Weight

1,7 kg

2,2 kg

2,4 kg

3,6 kg

LED

Light color	Color rendering Index CRI	Color consistency	Luminous flux	Energy efficiency class
2700 K	>97	2 Step	111 lm/W	E
3000 K	>97	2 Step	116 lm/W	E
S Dim2Warm	>95	3 Step	up to 97 lm/W	F
M Dim2Warm	>95	3 Step	up to 101 lm/W	F

Other versions (CCT/CRI) available on request.
LED light source replaceable by professionals
Average life 50,000 h (specification according to manufacturer).

Control gear

Control	Connected load	Operating voltage	Constant current / voltage	Feature
S TRIAC	11 W	230 V AC / 50 Hz	300 mA / 35 V	dimnable
S DALI	11 W	230 V AC / 50 Hz	300 mA / 35 V	dimnable, Touch DIM
M TRIAC	27 W	230 V AC / 50 Hz	700 mA / 35 V	dimnable
M DALI	27 W	230 V AC / 50 Hz	700 mA / 35 V	dimnable, Touch DIM

Control gear replaceable by professionals
The luminaire may be operated at a maximum of the constant current specified above.



DRUM

Suspension Tube

Photometric data sheet

DRUM Suspension Tube S short

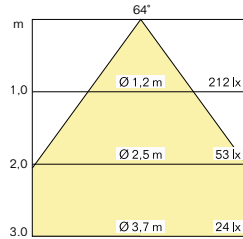
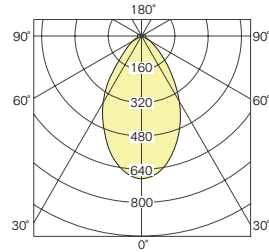

UGR ≤ 17

Light: directed downwards,
diffuse all around

Power	CRI	CCT	Luminous flux (measured value)
11 W	Ra>97 R9>80	2700 K	1000 lm
		3000 K	1050 lm

DRUM Suspension Tube S long

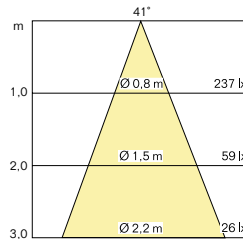
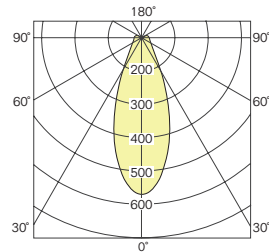

UGR ≤ 14

Light: directed downwards,
diffuse all around

11 W	Ra>97 R9>80	2700 K	780 lm
		3000 K	820 lm

DRUM Suspension Tube M short

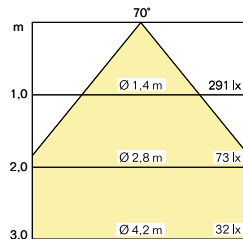
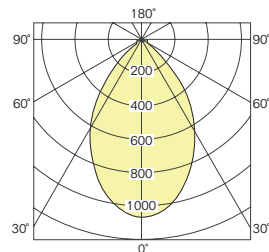

UGR ≤ 17

Light: directed downwards,
diffuse all around

27 W	Ra>97 R9>80	2700 K	2350 lm
		3000 K	2470 lm

DRUM Suspension Tube M long

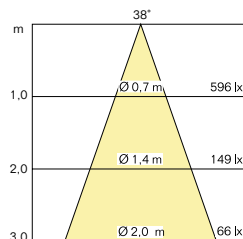
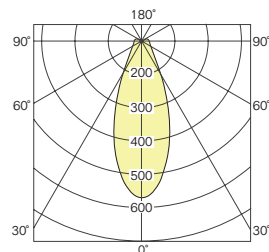

UGR ≤ 16



Light: directed downwards,
diffuse all around

27 W	Ra>97 R9>80	2700 K	1810 lm
		3000 K	1900 lm



⬇️ Note: The photometric data (EULUMDAT) can be downloaded from <https://serien.com/downloads/>

DRUM

Suspension Tube

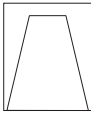

figure	description	lamp	control	power	CCT	art.-no.
	Tube lighting unit S	LED	TRIAC	11 W	2700 K	LE015707
					3000 K	LE015705
					1800-3000 K D2W	LE015709
			DALI	11 W	2700 K	LE015740
					3000 K	LE015741
					1800-3000 K D2W	LE015742
<input type="radio"/> 	glass S long with reflector					DU015801
<input type="radio"/> 	glass S short with reflector					DU015802

DRUM Suspension Tube M

figure	description	lamp	control	power	CCT	art.-no.
	Tube lighting unit M	LED	TRIAC	27 W	2700 K	LE015722
					3000 K	LE015723
					1800-3000 K D2W	LE015724
			DALI	27 W	2700 K	LE015725
					3000 K	LE015726
					1800-3000 K D2W	LE015727
<input type="radio"/> 	glass M long with reflector					DU015803
<input type="radio"/> 	glass M short with reflector					DU015804

DRUM is a modular article. Please order the lighting unit and glass shade together.

Information

+ C	+C indicates products with pre-programmed CASAMBI module integrated in the luminaire. The CASAMBI functionality is basically applicable to all our products. For the different possibilities of integration (depending on the temperature) – in the luminaire, in the suspended ceiling, in the switch or the distribution box) we will be pleased to inform you. CASAMBI is a lighting control system which is operated via Bluetooth and can be integrated completely into the luminaire or behind the light switch. It is controlled via mobile devices using the free CASAMBI app, making its operation simple and intuitive. CASAMBI expands the possibilities of control with new options such as dimming, the programming of specific scenarios or groups, automations and many more. For further information, please visit www.casambi.com .
CCT	CCT (Correlated Color Temperature) is the colour temperature of an LED and is specified in Kelvin (K). We supply LED lights with a colour temperature of 2700 K at short notice. LED lights with a color temperature of 3000 K and higher usually have longer delivery times.
CRI	Colour Rendering Index
D2W	Dim2Warm refers to a luminaire functionality that imitates the pleasant dimming behavior of classic incandescent lamps. When dimmed, the light not only becomes darker, but also changes its colour to warm white tone.
DALI 1-10 V	5-core mains cable required for control via DALI or 1–10 V. All LED luminaires operated with DALI power supply units are suitable for use in emergency lighting systems.
Lumen	The luminous flux (lumen) specifications are nominal values, i.e. pure module luminous flux values. The luminous flux indicates how much light radiates in all directions.
TW	Luminaires with this characteristic have variable colour temperature control from warm to cool white light.
UGR	Unified Glare Rating
IP	Protection class
LOR	The luminaire operating efficiency is given as a LOR value (Light Output Ratio) in percent.
	The crossed-out wheellie bin indicates that this electrical appliance must not be disposed of via household waste. In order to protect human health and the environment against potentially hazardous substances, at the end of its lifecycle this product can be taken to a collection point close to you and disposed of free of charge there. This separate disposal enables electrical appliances to be reused or recycled.
	At www.serien.com/downloads you will find helpful information and the latest technical data: Data sheets, catalogues, price lists, lighting data (EULUMDAT), 3D CAD data, EU Energy labels, declarations of conformity, returns form, FAQs, assembly instructions, drilling templates and other service instructions.
✓	This data sheet supersedes all previously published data sheet. The drawings shown in this document are for informational purposes only. Although great care has been taken when creating them, their proportions may not correctly reflect the proportions of the real product.
	All values are rated values. Power and luminous flux are subject to an initial tolerance of +/- 10%. Tolerance of color temperature: +/-150 K. When not otherwise indicated the values apply for an ambient temperature of 25 °C. The specified nominal and measured values refer to the illuminants used at the time the data sheet was prepared. Omissions excepted.

Imprint

serien Raumluchten GmbH, HRB 22042 Amtsgericht Offenbach. Managing Directors: Jean-Marc da Costa, Manfred Wolf. All rights reserved.
No reproductions without prior written consent. All trademarks are registered. All products are protected by law. Infringements will be prosecuted to the fullest extent. Subject to alteration without notice.